

FUTEK MODEL LAU200

Drawing Number: **FI1047-D**

INCH [mm] | R.O.= Rated Output

WIRING CODE (CC4)

+Excitation	-Excitation	+Signal	-Signal
RED	BLACK	GREEN	WHITE
1	4	2	3

ACCELERATOR AND PEDAL FORCE SENSOR

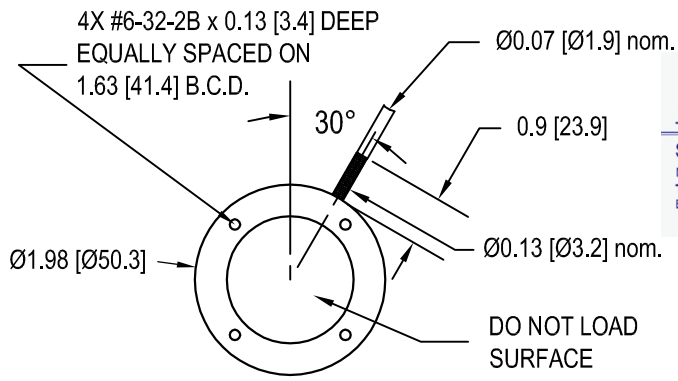
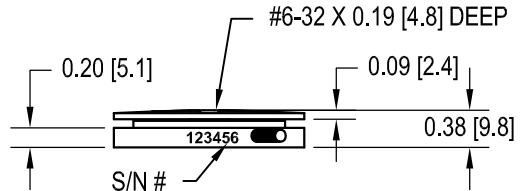
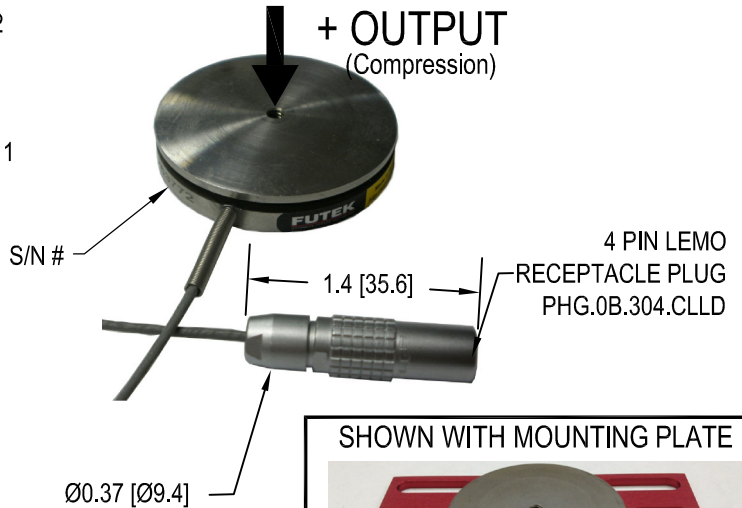
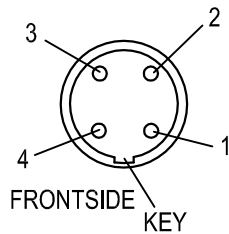

SCIENCE GATE
Your Automation Partner

SCIGATE AUTOMATION (S) PTE LTD
No.1 Bukit Batok Street 22 #01-01 Singapore 659592
Tel: (65) 6561 0488 Fax: (65) 6562 0588
Email: sales@scigate.com.sg Web: www.scigate.com.sg
Business Hours: Monday - Friday 8.30am - 6.15pm

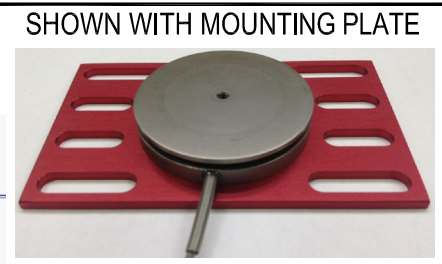

MODEL LAU200 INCLUDES (ONE OF EACH) TOTAL WEIGHT 2 lb [0.9 Kg]

ITEM#MCP00180 - MOUNTING PLATE
100 KOHM SHUNT CAL. CARRYING CASE AND
ITEM#FSH01790 - (mating connector and 15 ft cable)

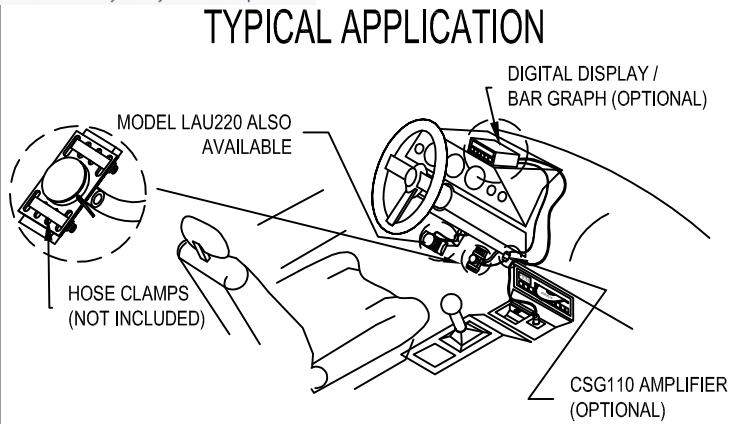

SPECIFICATIONS:

RATED OUTPUT	2 mV/V nom.
SAFE OVERLOAD	150% of R.O.
ZERO BALANCE	±1% of R.O.
EXCITATION (VDC OR VAC)	20 MAX
BRIDGE RESISTANCE	700 Ω nom.
OFF CENTER LOADING	±3-4% OR BETTER @ 0.625 [15.9] FROM CENTER
NONLINEARITY	±0.2% of R.O.
HYSTERESIS	±0.2% of R.O.
NONREPEATABILITY	±0.2% of R.O.
TEMP. SHIFT ZERO	±0.01% of R.O./°F [0.018% of R.O./°C]
TEMP. SHIFT SPAN	±0.01% of LOAD/°F [0.018% of LOAD/°C]
COMPENSATED TEMP.	60 to 160°F [15 to 72°C]
OPERATING TEMP.	-60 to 200°F [-50 to 93°C]
WEIGHT	6 oz [170 g]
MATERIAL	17-4PH S.S.

CAPACITIES		
ITEM #	lb	N
FSH00221	100	445
FSH00222	300	1334

MATERIAL (MOUNTING PLATE) Aluminum Red Anodized after S/N: 395536
DEFLECTION 0.002 to 0.005 [0.051 to 0.127] nom.
CABLE: #29 AWG, 4 Conductor, Spiral Shielded Teflon Cable
12 in (0.3 m) Long with 4 Pin LEMO Receptacle (PHG.0B.304.CLLD)
ACCESSORIES AND RELATED INSTRUMENTS AVAILABLE
5 pt. COMPRESSION; 100 KΩ SHUNT CAL VALUE
CALIBRATION TEST EXCITATION 10 VDC
CALIBRATION (STD)

MOUNTING PLATE (Aluminum, Red Anodized)

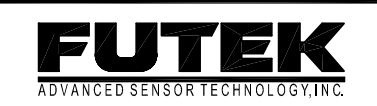
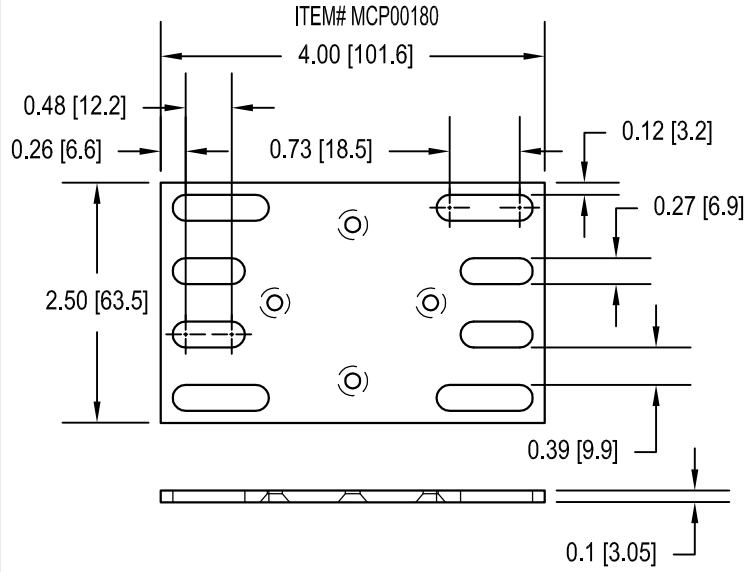

This drawing is submitted solely for the information and exclusive use of the original addressee. It is not to be divulged in whole or in part, by any firm or individual without written permission from FUTEK
CAGE CODE # 1X8M6

10 THOMAS IRVINE, CA 92618 USA
+1 (949) 465-0900

INTERNET:
<http://www.futek.com>