



## SCIGATE AUTOMATION (S) PTE LTD

Bukit Batok Street 22 #01-01 Singapore 659592

Tel: (65) 6561 0488

Fax: (65) 6561 0588

Email: [sales@scigate.com.sg](mailto:sales@scigate.com.sg)

Web: <https://scigate.com.sg/>



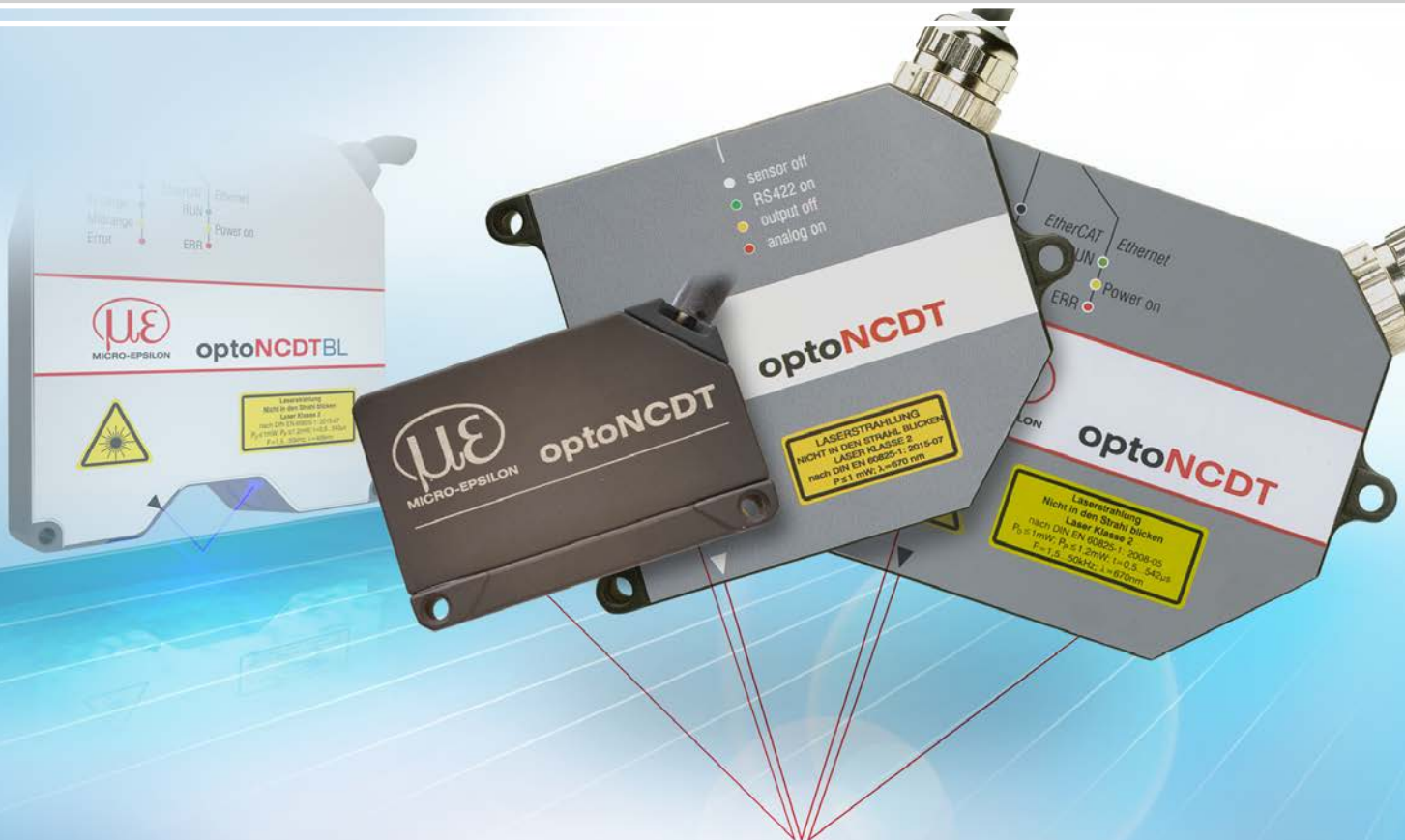

Business Hours: Monday - Friday 8:30AM - 6:15PM

# More Precision

**optoNCDT** // Laser displacement sensors (triangulation)





-  **Compact design with integrated controller**
-  **Measuring rate up to 7.5 kHz**  
312Hz  
375Hz  
1000Hz
- INTER FACE** **Analog (U/I)**  
**RS422 / PROFINET / EtherNet/IP**
-  **Trigger input/teach-in/zero-setting/mastering/synchronization**
-  **Configuration via web interface or Plug & Play**
-  **Real Time Surface Compensation**

The optoNCDT 1750 is a powerful laser triangulation sensor which is used in high speed, precise measurements in industrial applications. Innovation evaluation algorithms and enhanced components provide highest accuracy and dynamics. The high-performance optical system generates a small light spot onto the target which enables to even detect smallest components reliably. Due to its extremely compact size, the sensor can also be integrated into restricted installation spaces.

The optoNCDT 1750 laser stands out due to its real-time surface compensation feature. The real-time surface compensation feature (RTSC) determines the amount of reflection from the target surface during continuous exposure and in real-time. The exposure time or the amount of light produced by the laser is optimally matched to the reflection characteristics of the target surface. This enables extremely reliable measurements even on reflecting surfaces.

Different output signals enable to integrate the sensor into plant or machine control systems. As well as analog voltage and current outputs, a digital RS422 interface provides distance information from the sensor. All optoNCDT 1750 models are operated using an intuitive web interface. Due to the selectable setting and evaluation possibilities, the optoNCDT 1750 meets the requirements for use in industrial applications with high dynamics.

optoNCDT 1750 (2/10/20/50/100/200 mm)

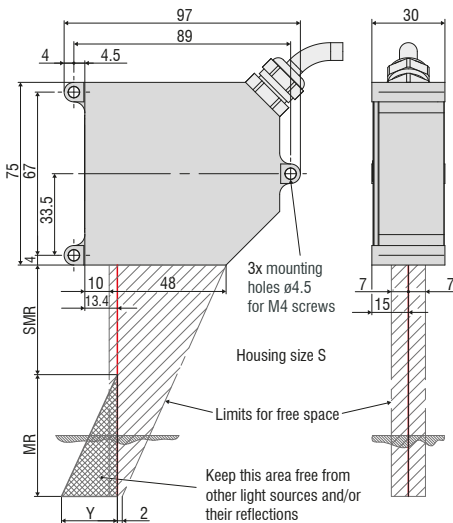

optoNCDT 1750 (500/750 mm)

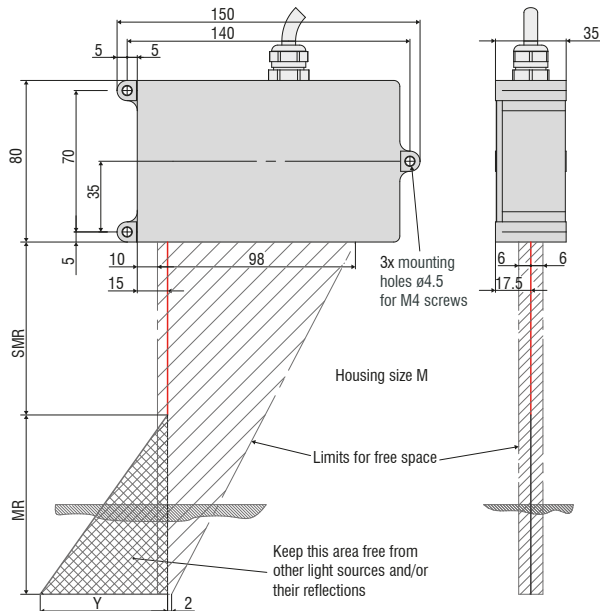

MR	SMR	Y
2	24	2
10	30	7
20	40	12
50	45	25
100	70	35
200	70	70
500	200	180
750	200	270

Connector (sensor side)

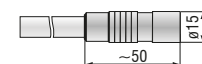

Model		ILD1750-2	ILD1750-10	ILD1750-20	ILD1750-50	ILD1750-100	ILD1750-200	ILD1750-500	ILD1750-750
Measuring range		2 mm	10 mm	20 mm	50 mm	100 mm	200 mm	500 mm	750 mm
Start of measuring range		24 mm	30 mm	40 mm	45 mm	70 mm	70 mm	200 mm	200 mm
Mid of measuring range		25 mm	35 mm	50 mm	70 mm	120 mm	170 mm	450 mm	575 mm
End of measuring range		26 mm	40 mm	60 mm	95 mm	170 mm	270 mm	700 mm	950 mm
Measuring rate <sup>1)</sup>		continuously adjustable between 0.3 ... 7.5 kHz							
		6 adjustable stages: 7.5 kHz / 5 kHz / 2.5 kHz / 1.25 kHz / 625 Hz / 300 Hz							
Linearity		< ±1.6 μm	< ±6 μm	< ±12 μm	< ±30 μm	< ±60 μm	< ±160 μm	< ±350 μm	< ±670 μm
		< ±0.08 % FSO	< ±0.06 % FSO				< ±0.08 % FSO	< ±0.07 % FSO	< ±0.09 % FSO
Repeatability <sup>2)</sup>		0.1 μm	0.4 μm	0.8 μm	2 μm	4 μm	8 μm	20 μm	30 μm
Light spot diameter (±10 %)	SMR	80 μm	110 μm	320 μm	570 μm	740 μm	1300 μm	1500 μm	
	MMR	35 μm	50 μm	45 μm	55 μm	60 μm			
	EMR	80 μm	110 μm	320 μm	570 μm	700 μm			
Light source		Semiconductor laser < 1 mW, 670 nm (red)							
Laser safety class		Class 2 in accordance with DIN EN 60825-1: 2015-07							
Permissible ambient light		10,000 lx							
Supply voltage		11 ... 30 VDC							
Power consumption		< 3 W (24 V)							
Signal input		1 x HTL/TTL laser on/off; 1 x HTL/TTL multi-function input: trigger in, slave in, zero setting, mastering, teach-in; 1 x RS422 synchronization input: trigger in, sync in, master/slave, master/slave alternating							
Digital interface		RS422 (16 bit) / PROFINET <sup>3)</sup> / EtherNet/IP <sup>3)</sup>							
Analog output		4 ... 20 mA / 0 ... 5 V / 0 ... 10 V (16 bit, freely scalable within the measuring range)							
Switching output		2 x switching output (error & limit value): npn, pnp, push pull							
Synchronization		possible for simultaneous or alternating measurements							
Connection		integrated pigtail 0.25 m with 14-pin cable connector, min. bending radius 30 mm (fixed installation); optional extension to 3 m / 10 m possible (see accessories for suitable connection cable)							
Installation		Screw connection via three mounting holes							
Temperature range	Storage	-20 ... +70 °C (non-condensing)							
	Operation	0 ... +50 °C (non-condensing)							
Shock (DIN EN 60068-2-29)		15 g / 6 ms in 3 axes							
Vibration (DIN EN 60068-2-6)		2 g / 20 ... 500 Hz							
Protection class (DIN EN 60529)		IP65							
Material		Die-cast zinc housing						Aluminum housing	
Weight		approx. 550 g (incl. pigtail)						approx. 600 g (incl. pigtail)	
Control and display elements		Select & function keys: interface selection, mastering (zero), teach, presets, quality slider, frequency selection, factory settings; web interface for setup <sup>4)</sup> : application-specific presets, peak selection, video signal, freely selectable averaging possibilities, data reduction, setup management; 2 x color LEDs for power / status							

FSO = Full Scale Output

SMR = Start of measuring range, MMR = Mid of measuring range, EMR = End of measuring range

The specified data apply to white, diffuse reflecting surfaces (Micro-Epsilon reference ceramic for ILD sensors)

<sup>1)</sup> Factory setting 5 kHz, modifying the factory setting requires the IF2001/USB converter (see accessories)

<sup>2)</sup> Measuring rate 5 kHz, median 9

<sup>3)</sup> Optional connection via interface module (see accessories)

<sup>4)</sup> Connection to PC via IF2001/USB (see accessories)

### Accessories for all optoNCDT series (except for LD16x0)

#### Power supply

- PS 2020 (power supply 24 V / 2.5 A, input 100 - 240 VAC, output 24 VDC / 2.5 A, mounting onto symmetrical standard rail 35 mm x 7.5 mm, DIN 50022)

#### Controller unit for evaluation and signal conversion

- C-Box/2A (controller for conversion and evaluation of up to 2 sensor signals)

#### Interface card

- IF2008PCI / IF2008PCle (interface card for multiple signal processing; analog and digital interfaces)

#### USB converter

- IF2001/USB RS422/USB converter (converter for digital signals in USB)
- IF2004/USB 4-channel RS422/USB converter (converter for up to 4 digital signals in USB)

#### Interface module for Industrial Ethernet connection

- IF2030/PNET
- IF2030/ENETIP

### Accessories optoNCDT 1420/1402CL1

#### Supply and output cable (drag-chain suitable)

- PCF1420-1/I (1 m, output 4 ... 20 mA)
- PCF1420-1/I(01) (1 m, output 4...20 mA)
- PCF1420-3/I (3 m, output 4 ... 20 mA)
- PCF1420-6/I (6 m, output 4 ... 20 mA)
- PCF1420-10/I (10 m, output 4 ... 20 mA)
- PCF1420-15/I (15 m, output 4 ... 20 mA)
- PCF1420-3/U (3 m, with integrated resistor, output 1 ... 5 VDC)\*
- PCF1420-6/U (6 m, with integrated resistor, output 1 ... 5 VDC)\*
- PCF1420-10/U (10 m, with integrated resistor, output 1 ... 5 VDC)\*
- PCF1420-15/U (15 m, with integrated resistor, output 1 ... 5 VDC)\*
- PCF1420-3/IF2008 (3 m, interface and supply cable)
- PCF1420-6/IF2008 (6 m, interface and supply cable)
- PCF1420-10/IF2008 (10 m, interface and supply cable)
- PCF1420-3/C-Box (3 m)

\* on request with output 2 ... 10 VDC

#### Supply and output cable, suitable for use with robots

(available in 90° version)

- PCR1402-3/I (3 m)
- PCR1402-6/I (6 m)
- PCR1402-8/I (8 m)

### Accessories for optoNCDT 1610/1630

#### Supply and output cable

- PC1605-3 (3 m)
- PC1605-6 (6 m)
- PC1607-5/BNC (5 m, BNC connector)

### Accessories for optoNCDT 1750BL / 1750DR / 1710 / 1710BL

#### Supply and output cable (drag-chain suitable)

- PC1700-3 (3 m)
- PC1700-10 (10 m)
- PC1700-10/IF2008 (10 m, for use with interface card IF2008)
- PC1750-3/C-Box (3 m)
- PC1750-6/C-Box (6 m)
- PC1750-9/C-Box (9 m)

#### Supply and output cable (suitable for use with robots)

- PCR1700-5 (5 m)
- PCR1700-10 (10 m)

#### Supply and output cables for temperatures up to 200 °C

- PC1700-3/OE/HT (3 m)
- PC1700-6/OE/HT (6 m)
- PC1700-15/OE/HT (15 m)

#### Protection housing

- SGH model (sizes S and M)
- SGHF model (sizes S and M)
- SGHF-HT model

### Accessories for optoNCDT 2300/2300LL/2300BL/2300-2DR

#### Supply and output cable

- PC2300-0,5Y (connection cable to PC or PLC; for operation a PC2300-3/SUB-D will be required)
- PC2300-3/SUB-D (3 m; for operation a PC2300-0,5Y will be required)
- PC2300-3/IF2008 (interface and supply cable)
- PC2300-3/OE (3 m)
- PC2300-6/OE (6 m)
- PC2300-9/OE (9 m)
- PC2300-15/OE (15 m)
- PC2300-3/C-Box/RJ45 (3 m)

\* other cable lengths on request

#### Protection housing

- SGH model (sizes S and M)
- SGHF model (sizes S and M)
- SGHF-HT model

#### Supply and output cables for temperatures up to 200 °C

- PC2300-3/OE/HT (3 m)
- PC2300-6/OE/HT (6 m)
- PC2300-9/OE/HT (9 m)
- PC2300-15/OE/HT (15 m)

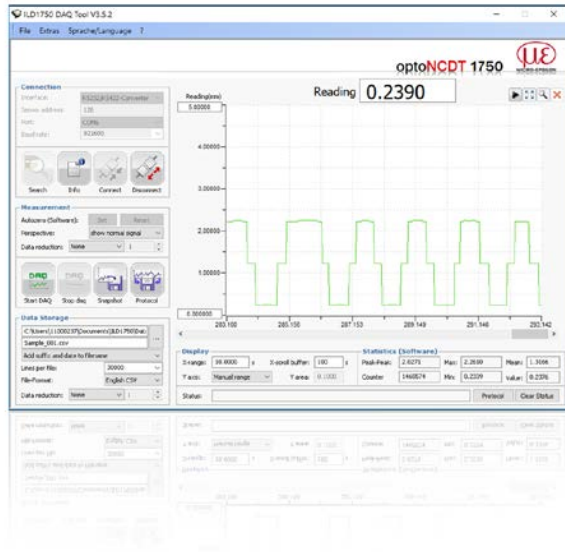

### optoNCDT Demo Tool

The scope of supply includes a software for easy sensor configuration. The settings can be implemented conveniently via a Windows user interface on the PC. The sensor parameters are transmitted to the sensor via the serial port and can also be saved if required. The software is available as single and multi-channel version. The sensor is connected to the PC via the sensor cable using a USB converter. [for any ILD sensor]

### Free download

Download free of charge from [www.micro-epsilon.com/download](http://www.micro-epsilon.com/download): software, driver and well-documented driver DLL for easy sensor integration in existing or customer software.

### Protection housing for demanding environments

To protect the optoNCDT laser sensors in harsh environments, protective housings are available in different designs.

#### SGH model

Completely enclosed housing with an integrated front window, where the sensor measures through the window. The water-resistant housing provides protection against solvents and detergents.

#### SGHF model

With window and compressed-air connection ideal for high ambient temperatures. The integrated air cooling of the housing offers optimum protection for the sensor.

#### SGHF-HT model

This water-cooled protection housing with window and compressed-air connection is designed for measurement tasks in ambient temperatures up to 200 °C.

Suitable for all long-range sensors

optoNCDT 1710

optoNCDT 1750-500 and optoNCDT 1750-750

optoNCDT 2310

optoNCDT 2300 - 200

Maximum ambient temperature 200 °C

Maximum temperature of cooling water  $T(\text{max}) = 10\text{ °C}$

Minimum water flow rate  $Q(\text{min}) = 3\text{ liters/min}$



SGHx ILD size S (140x140x71 mm)  
for optoNCDT 1750 / 2300 dimensions 97x75 mm



SGHx ILD size M (140x180x71 mm)  
for optoNCDT 1750 / 2300 dimensions 150x80 mm

### IF2008PCI/IF2008PCIe - PCI Interface card for synchronous data acquisition

The absolutely synchronous data acquisition is a decisive factor for the planarity or thickness measurement using several laser sensors. The IF2008PCI interface card is designed for installation in PCs and enables the synchronous capture of four digital sensor signals and two encoders. The data are stored in a FIFO memory in order to enable resource-saving processing in blocks in the PC. The IF2008E expansion board enables to detect in addition two digital sensor signals, two analog sensor signals and eight I/O signals.

#### Special features

- IF2008 basic printed circuit board: 4 digital signals and 2 encoders
- IF2008E - Expansion board: 2x digital signals, 2x analog signals and 8x I/O signals

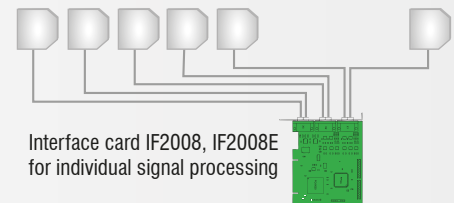
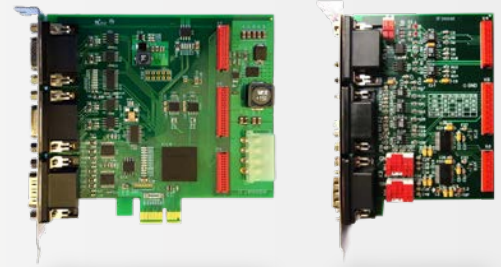

### IF2001/USB converter RS422 to USB

The RS422/USB converter transforms digital signals from a laser-optical sensor into a USB data packet. The sensor and the converter are connected via the RS422 interface of the converter. Data output is done via USB interface. The converter loops through further signals and functions such as laser on/off, switch signals and function output. The connected sensors and the converter can be programmed through software.

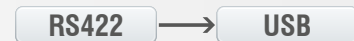
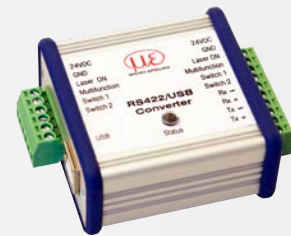

### IF2004/USB: 4-channel converter from RS422 to USB

The RS422/USB converter is used for transforming digital signals from up to four optical sensors into USB data signals. The converter has four trigger inputs and a trigger output for connecting additional converters. Data is output via an USB interface. The connected sensors and the converter can be programmed through software.

#### Special features

- 4x digital signals via RS422
- 4x trigger inputs, 1x trigger output
- Synchronous data acquisition
- Data output via USB

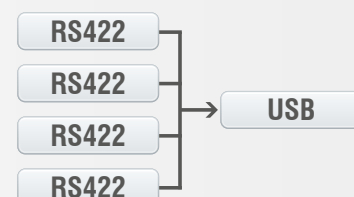

### C-Box/2A Controller for D/A conversion and evaluation

C-Box/2A is used for fast D/A conversion of two digital input signals or for evaluating two digital sensor signals. The controller is compatible with the optoNCDT 1420, 1750 und 2300 models. Handling of the C-Box/2A and of the connected sensors are performed via web interface. Averaging functions, thickness, diameter, step and inclinations can be calculated. The D/A conversion is executed at 16 bit and max. 70 kHz.



#### Special features

- Trigger input
- Multi-function output
- Measurement value output via Ethernet, USB, analog output  
4 ... 20 mA / 0 ... 5 V / 0 ... 10 V /  $\pm 5$  V /  $\pm 10$  V  
(scalable via web interface)
- 2x switching outputs for sensors or C-Box/2A status
- Parallel data output via 3 output interfaces

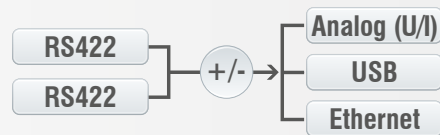

### IF2030

#### Interface module for Industrial Ethernet connection

The IF2030 interface modules are designed for easy connection of Micro-Epsilon sensors to Ethernet-based fieldbuses, e.g., plant control systems. The PROFINET and Ethernet/IP modules are compatible with sensors that output data via an RS422 or RS485 interface. These modules operate on the sensor side with up to 4 MBd and have two network connections for different network topologies. Installation in switching cabinets is via a DIN rail.



EtherNet/IP

PROFINET

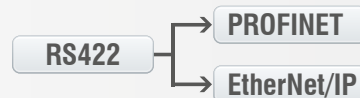

## Sensors and Systems from Micro-Epsilon



Sensors and systems for displacement, distance and position



Sensors and measurement devices for non-contact temperature measurement



Measuring and inspection systems for metal strips, plastics and rubber



Optical micrometers and fiber optics, measuring and test amplifiers



Color recognition sensors, LED analyzers and inline color spectrometers

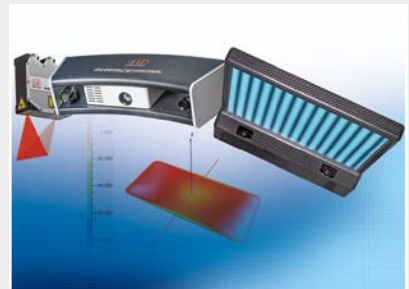

3D measurement technology for dimensional testing and surface inspection