



**SCIGATE AUTOMATION (S) PTE LTD**

Bukit Batok Street 22 #01-01 Singapore 659592

Tel: (65) 6561 0488

Fax: (65) 6561 0588

Email: [sales@scigate.com.sg](mailto:sales@scigate.com.sg)

Web: <https://scigate.com.sg/>

Business Hours: Monday - Friday 8:30AM - 6:15PM

# More Precision

capa**NCDT** MD6-22 // Mobile gap gauge





- High-precision gap measurement
- Intuitive operation
- For electrically conductive measurement objects
- Comprehensive sensor portfolio
- Cable lengths up to 4 m

**Mobile gap measurement at the highest precision**

The capaNCDT MD6-22 gauge is a capacitive dual-channel handheld gauge which is compatible with all capacitive sensors from Micro-Epsilon. This measuring system is used in mobile gap and distance measurements and impresses with high accuracy, versatile application possibilities and intuitive operation.

Supported with up to 5h battery life and storage of measurement data on SD card, the MD6-22 is ideally suited to mobile applications in service and maintenance tasks. For example, it is used for rotor gap monitoring in wind turbines and to measure the air gap between the turbine blade and the housing.

This handheld measuring instrument offers four different measurement modes:

**Single-sided gap measurement**

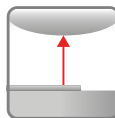

Mode for optimal gap measurement on curved surfaces with gap sensors measuring one side (sensor alignment subordinated).

**Double-sided gap measurement**



Mode for precise gap measurement on flat surfaces with compensation of sensor alignment. Gap sensors measuring two sides are used.

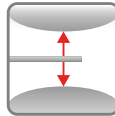

Mode for optimal gap measurement on curved surfaces with gap sensors measuring two sides (sensor alignment subordinated).

**Single-value measurement with math function**

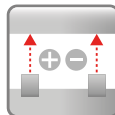

Mode for signal calculation of two sensors measuring one side.

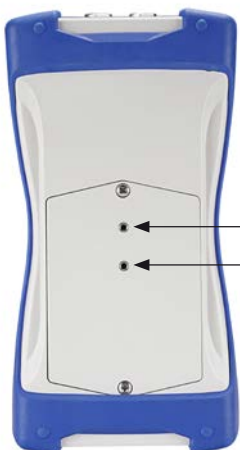

**Included in delivery:**

- Robust carry case
- Handheld measuring instrument MD6-22
- capaNCDT sensor with integrated cable
- Power supply unit / international / 24V / DC / 1A
- Magnetic holder incl. Allen wrench for installation
- 4 x batteries NiMH / Mignon (AA, HR6)
- Cable for ground connection

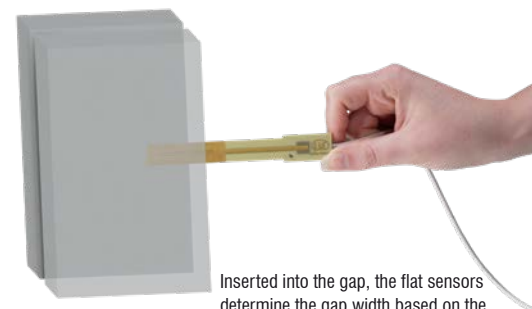

Inserted into the gap, the flat sensors determine the gap width based on the active measuring area. Gaps up to 12 mm can be detected reliably.



**Rotor gap measurement in the generator**

The MD6-22 is used for commissioning and maintenance of generators. Inserted into the rotor gap, the flat sensors detect the distance.

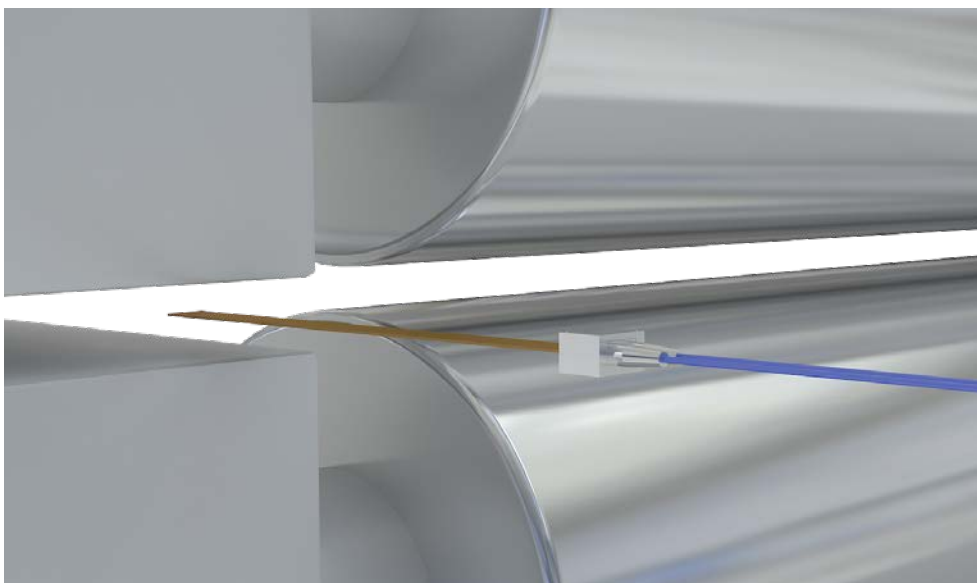
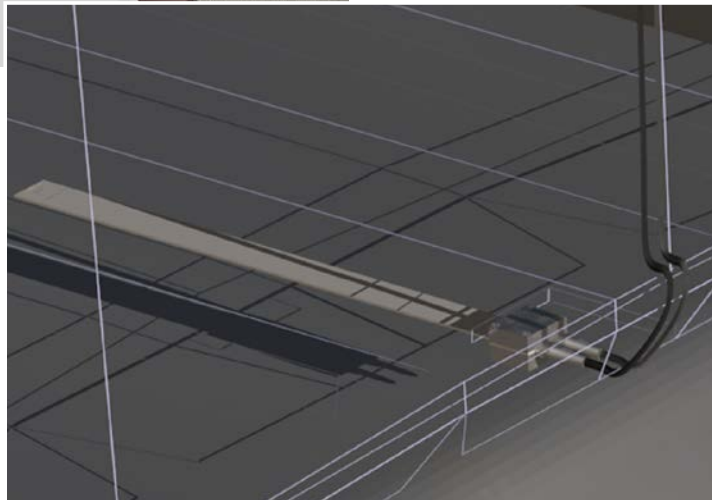

**Alignment of rollers**

The MD6-22 is used to adjust rollers. Used in commissioning and service tasks, the double-sided flat sensor determines the roller gap.



### Mobile gap gauge

The MD6-22 handheld gauge calculates the sensor signals. It has two connections for two sensors or one dual-channel sensor. The rear magnet enables on-site mounting. Based on intuitive touch operation, all parameters can be set quickly. The measurement values are displayed and can be stored on an SD card.

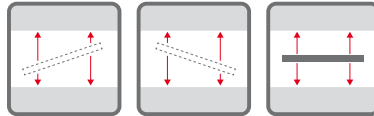

### Automatic gap detection

Automatic gap detection simplifies parallel alignment of flat sensors for double-sided measurements, while the sensor is rotated around its longitudinal axis. The system recognizes the correct gap width and displays it.

### Calibrated system for measurements independent of the alloy

The capacitive measuring principle enables measurements on all conductive measurement objects. The sensor and the controller are factory-calibrated and matched to one another. When replacing the sensors, recalibration in the factory is recommended in order to maintain the high measurement accuracy. Up to 5 different characteristic curves can be stored in the handheld gauge.

Model	MD6-22	
Resolution	dynamic 100 Hz	0.02 % FSO
Frequency response (-3dB)		100 Hz
Linearity		< ± 0.2 % FSO
Temperature stability		< 200 ppm FSO / K
Sensitivity		< ± 0.2 % FSO
Long-term stability		< 0.04 % FSO / month
Synchronization		yes
Connection		Sensor: 2 x sockets (type B)
Temperature range	Storage	-10 ... +65 °C
	Operation	+10 ... +50 °C
Shock (DIN-EN 60068-2-29)		40 g / half-sine 6 ms in XYZ axes / 1000 shocks per axis
Vibration (DIN-EN 60068-2-6)		10 g rms / 10 ... 500 Hz in XYZ axes / 30 minutes per axis
Protection class (DIN-EN 60529)		IP30
No. of measurement channels		2
Weight		500 g (without magnetic holder)
Battery life		5 hours (with 2500 mAh)
Control and Display Elements		Touch display
Compatibility		compatible with all capaNCDT sensors
Features	2 synchronized measurement channels, storage of measured values on micro SD/SDHC card (not included, max. storage capacity 32 GB)	

FSO = Full Scale Output

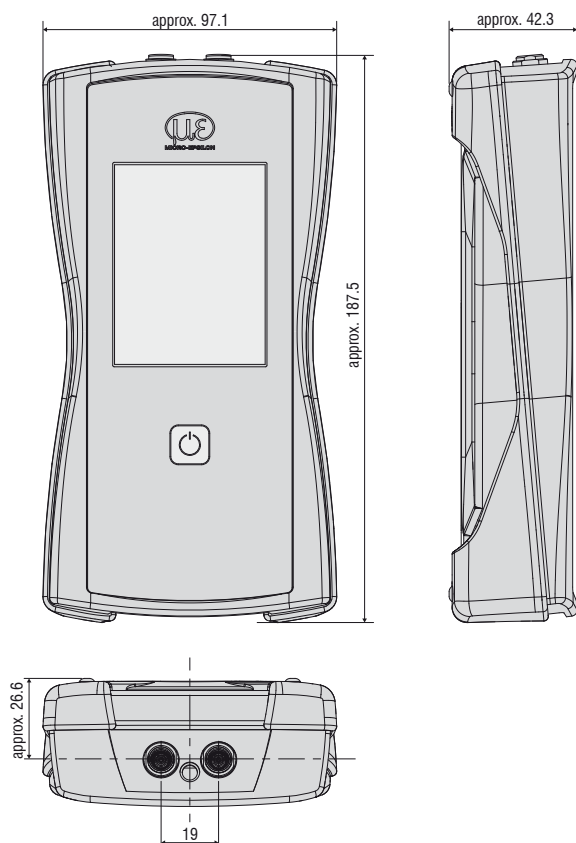

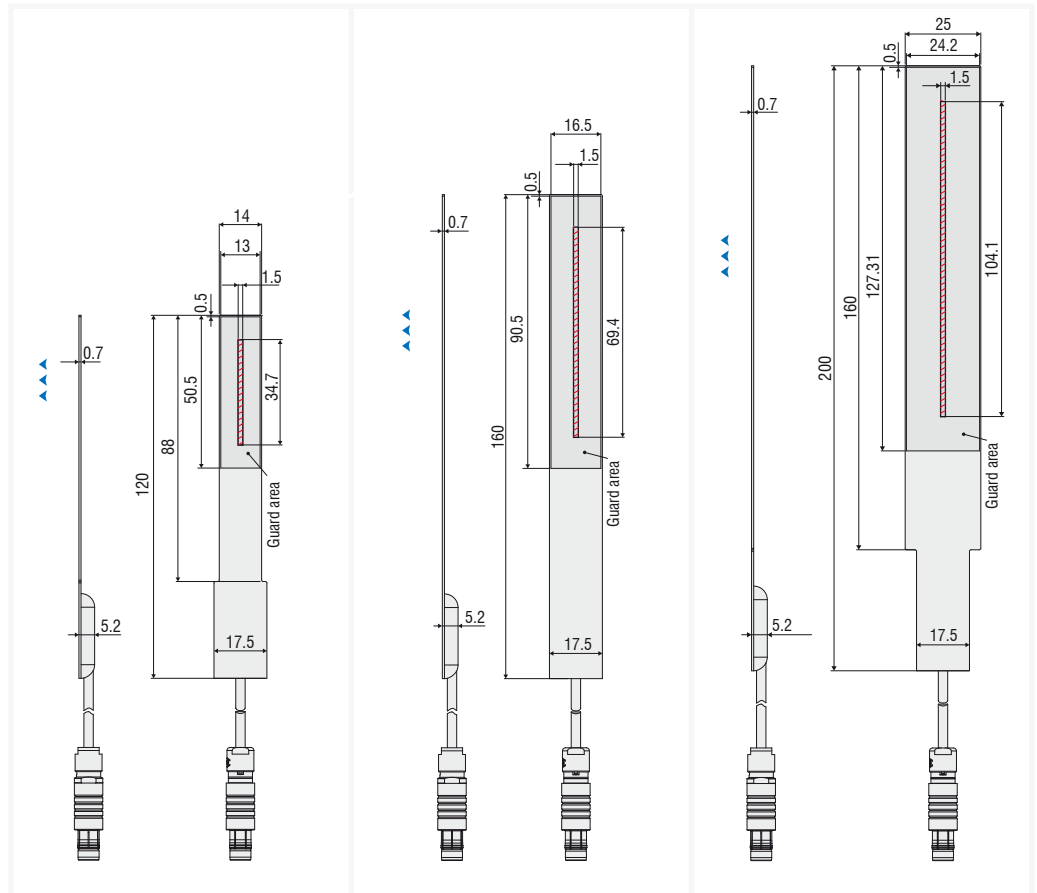
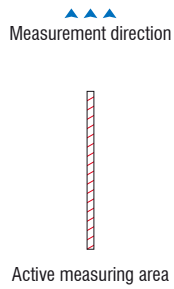

Model	CSF2-CRg4.0	CSF4-CRg4.0	CSF6-CRg4.0
Measuring range	4 mm	8 mm	12 mm
Resolution <sup>1)</sup> dynamic 100 Hz	0.8 μm	1.6 μm	2.4 μm
Linearity <sup>1)</sup>	< ± 8 μm	< ± 16 μm	< ± 24 μm
Temperature stability <sup>2)</sup>	< 0.8 μm / K	< 1.6 μm / K	< 2.4 μm / K
Required gap width		≥ 0.75 mm	
Min. target size (flat)	approx. 50.5 x 14 mm	approx. 90.5 x 17.5 mm	approx. 127.31 x 25 mm
Connection	integrated cable; standard length 4 m;		
Temperature range	Storage	-20 ... +85 °C	
	Operation	-20 ... +85 °C	
	Operation (<10,000 h)	-40 ... +100 °C	
Humidity <sup>3)</sup>	0 ... 95 % r.H.		
Shock (DIN-EN 60068-2-29) <sup>4)</sup>	30 g / 5 ms in XY axes / 1000 shocks per axis		
Vibration (DIN-EN 60068-2-6) <sup>4)</sup>	20 g / 58 Hz ... 2000 Hz in XY axes / 10 cycles per axis		
Protection class (DIN-EN 60529)	IP40		
Material	Hard tissue (GFRP)		
Weight	75 g (incl. cable and plug)	77 g (incl. cable and plug)	80 g (incl. cable and plug)

<sup>1)</sup> Valid when operated with MD6-22  
<sup>2)</sup> Valid when system is not installed  
<sup>3)</sup> Non condensing  
<sup>4)</sup> With locked connector

**Connector type B**

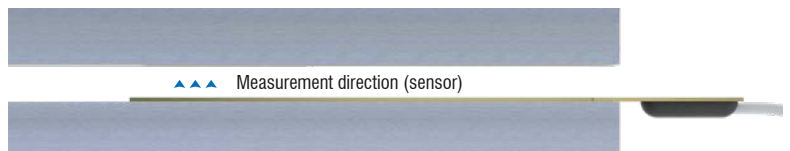
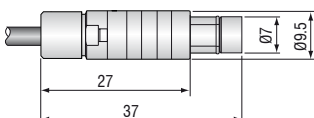

Minimum bending radius (sensor cable) > 10 mm, dynamic > 22 mm (30 mm recommended)

▲▲▲  
Measurement direction

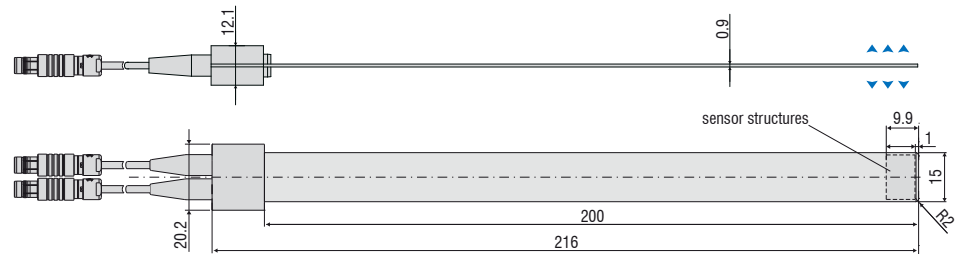

▨  
Active measuring area

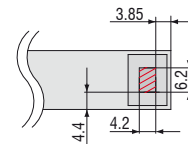
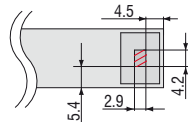

Model	CSG0,50-CAM2,0	CSG1,00-CAM2,0
Measuring range <sup>1)</sup>	1 mm	2 mm
Resolution <sup>2)</sup>	dynamic 100 Hz 0.4 μm	0.8 μm
Linearity <sup>2)</sup>	< ± 4 μm	< ± 8 μm
Temperature stability	< 0.4 μm / K	< 0.8 μm / K
Required gap width	≥ 0.9 mm	
Min. target size (flat)	approx. 9.9 x 15 mm	
Connection	integrated cable; standard length 2 m;	
Temperature range	Storage	-50 ... +100 °C
	Operation	-50 ... +100 °C
Humidity <sup>3)</sup>	0 ... 95 % r.H.	
Shock (DIN-EN 60068-2-29) <sup>4)</sup>	30 g / 5 ms in XY axes / 1000 shocks per axis	
Vibration (DIN-EN 60068-2-6) <sup>4)</sup>	20 g / 58 Hz ... 2000 Hz in XY axes / 10 cycles per axis	
Protection class (DIN-EN 60529)	IP40	
Material	Hard tissue (GFRP)	
Weight	77 g (incl. cable and plug)	

<sup>1)</sup> Measuring range per measurement direction  
<sup>2)</sup> Valid with operation with reference configuration  
<sup>3)</sup> Non-condensing  
<sup>4)</sup> With locked connector

Connector type B

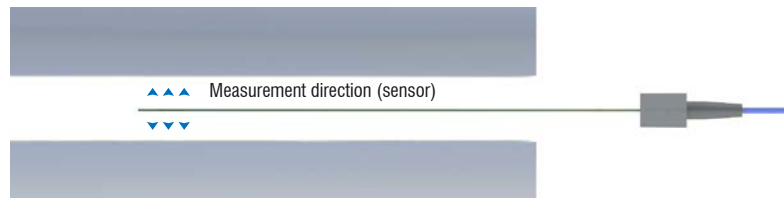
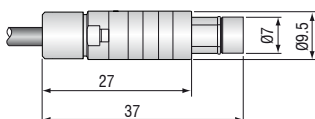

Minimum bending radius (sensor cable) > 7 mm, dynamic > 15 mm (25 mm recommended)

## Sensors and Systems from Micro-Epsilon



Sensors and systems for displacement, distance and position



Sensors and measurement devices for non-contact temperature measurement



Measuring and inspection systems for metal strips, plastics and rubber



Optical micrometers and fiber optics, measuring and test amplifiers



Color recognition sensors, LED analyzers and inline color spectrometers

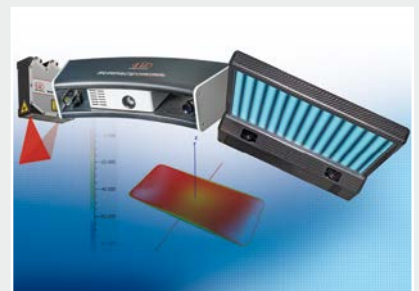

3D measurement technology for dimensional testing and surface inspection