



## SCIGATE AUTOMATION (S) PTE LTD

No.1 Bukit Batok Street 22 #01-01 Singapore 659592

Tel: (65) 6561 0488

Fax: (65) 6562 0588

Email: sales@scigate.com.sg

Web: www.scigate.com.sg

Business Hours: Monday - Friday 8.30am - 6.15pm

# More Precision

capa**NCDT** // Capacitive displacement sensors and systems





#### Measuring principle

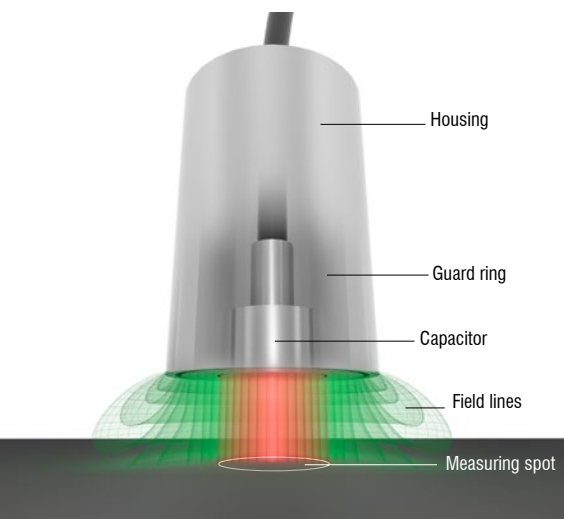

#### Measuring principle

The principle of capacitive displacement measurement using the capaNCDT (capacitive Non-Contact Displacement Transducer) system is based on how an ideal plate-type capacitor operates. The two plate electrodes are represented by the sensor and the opposing measurement object. If a constant alternating current flows through the sensor capacitor, the amplitude of the alternating voltage on the sensor is proportional to the distance between the capacitor electrodes. The alternating current is demodulated and output as, for example, an analog signal.

#### Use of capacitive sensors

The sensors measure against all electrically conductive materials, and with appropriate electronic circuitry even against insulators. Capacitive sensors are applied for displacement, position and thickness measurement.

#### Benefits of the measuring principle

- Wear-free and non-contact measurement
- Distance and thickness measurements on conductive and non-conductive objects
- Unmatched accuracy and stability
- High bandwidth for fast measurements
- Ideal for industrial environments, magnetic fields and vacuum

#### Unmatched precision

Practice shows that capaNCDT measuring systems achieve excellent results in terms of linearity, repeatability and resolution. While sub-micrometer precision is reached in industrial environments, high-precision sub-nanometer measurements are carried out in clean environments.



#### Modern and user-friendly controller technology

Modern capaNCDT controllers are the ideal basis for different fields of applications. Various interfaces and ease of use via web interface allow for a fast integration into the respective application environment.

Capacitive sensors <b>Cylindrical sensors, flat sensors</b>	Page 04 - 11	High resolution measuring system <b>capaNCDT 6500</b>	Page 12 - 15
Modular multi-channel measuring system <b>capaNCDT 6200</b>	Page 16 - 19	Compact single channel system <b>capaNCDT 6110</b>	Page 20 - 21
Sensor system for thickness measurement <b>combiSENSOR</b>	Page 22 - 23	Accessories / Technical Information	Page 24 - 31

### Triaxial sensor design with active sensor cable

The completely triaxial sensor design is unique for capaNCDT sensors. The guard ring electrode, the grounding and the measurement electrode are located on the front edge of the sensor. The guard ring electrode ensure a homogenous measuring field which is why precise measurements can be achieved with highest signal stability. The sensor cable, which is extremely low noise, enables an impermeable electrical shield. Due to the triaxial design, the sensors are insensitive to magnetic interference fields and can be mounted flush in conductive materials. The sensors can also come into contact with each other in the case of multi-channel measurements.

### Sensor and controller exchange without calibration

The capacitive measuring principle specially developed by Micro-Epsilon enables the simple change of a sensor in just a few seconds. This simplified replacement of sensors with different measuring ranges and the interchange of different capaNCDT controllers can be easily carried out without any recalibration. A sensor replacement normally takes around 5 seconds, unlike conventional systems, which have to be subjected to time-consuming calibration and linearization.

### Non-contact target grounding

Unlike conventional systems, the target for synchronization of two capaNCDT devices does not necessarily have to be grounded. However, maximum signal quality is only achieved when the measurement object is correctly grounded.

### Sensors for customer-specific applications and OEM

For special requirements that are not met by standard models, the capacitive sensors can be suitably modified. Changes often requested include for example modified designs, target coordination, mounting options, individual cable lengths, modified measuring ranges or sensors with integrated controller.

capaNCDT sensor with triaxial design

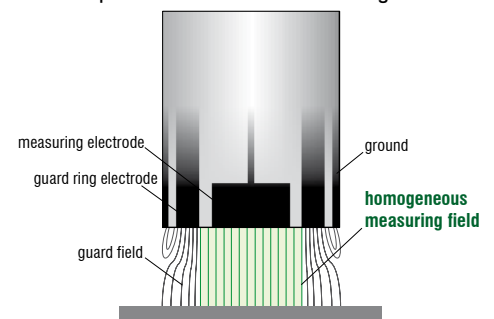

Common capacitive sensor (coaxial)

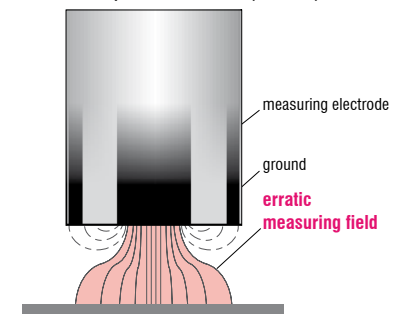

### Unmatched precision

- Resolution from 0.0375nm
- Linearity from 0.1µm
- Repeatability from 0.0003% FSO



### High stability

- Temperature stability 5 ppm (temperature range -270°C to +200°C, higher temperatures on request)
- Long-term stability ±0.002 % FSO / month



### Comprehensive portfolio of sensors

- More than 30 standard sensors with measuring ranges from 0.05mm to 10mm
- Controller operated via web browser, calculation functions, analog interface, Ethernet and EtherCAT

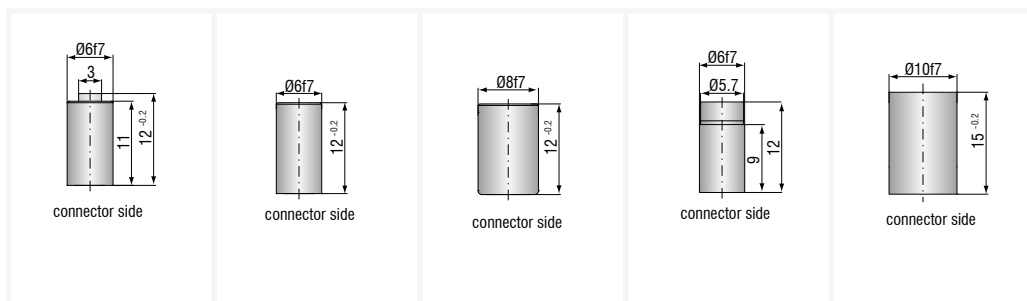

Sensor type		CS005	CS02	CS05	CSE05	CS08
Article No.		6610083	6610051	6610053	6610102	6610080
Measuring range	reduced	0.025 mm	0.1 mm	0.25 mm	0.25 mm	0.4 mm
	nominal	0.05 mm	0.2 mm	0.5 mm	0.5 mm	0.8 mm
	extended	0.1 mm	0.4 mm	1 mm	1 mm	1.6 mm
Linearity <sup>1)</sup>		≤ ±0.15 μm	≤ ±0.4 μm	≤ ±0.15 μm	≤ ±0.5 μm	≤ ±0.4 μm
		≤ ±0.3 % FSO	≤ ±0.2 % FSO	≤ ±0.03 % FSO	≤ ±0.1 % FSO	≤ ±0.2 % FSO
Resolution <sup>1) 2)</sup>	static 2 Hz	0.0375 nm	0.15 nm	0.375 nm	0.375 nm	0.6 nm
	dynamic 8.5 kHz	1 nm	4 nm	10 nm	10 nm	16 nm
Temperature stability	Zero <sup>5)</sup>	-60 nm/K	-60 nm/K	-60 nm/K	-60 nm/K	-60 nm/K
	Sensitivity	-0.5 nm/K	-2 nm/K	-5 nm/K	-5 nm/K	-8 nm/K
Temperature range	Operation	-50 ... +200 °C	-50 ... +200 °C	-50 ... +200 °C	-50 ... +200 °C	-50 ... +200 °C
	Storage	-50 ... +200 °C	-50 ... +200 °C	-50 ... +200 °C	-50 ... +200 °C	-50 ... +200 °C
Humidity <sup>3)</sup>		0 % ... 95 % r.H.	0 % ... 95 % r.H.	0 % ... 95 % r.H.	0 % ... 95 % r.H.	0 % ... 95 % r.H.
Dimensions		Ø6 × 12 mm	Ø6 × 12 mm	Ø8 × 12 mm	Ø6 × 12 mm	Ø10 × 15 mm
Active measuring area		Ø1.3 mm	Ø2.3 mm	Ø3.9 mm	Ø3.9 mm	Ø4.9 mm
Guard ring width		0.8 mm	1 mm	1.4 mm	0.8 mm	1.6 mm
Minimum target diameter		Ø3 mm	Ø5 mm	Ø7 mm	Ø6 mm	Ø9 mm
Weight		2 g	2 g	4 g	2 g	7 g
Material	Housing	NiFe <sup>4)</sup> (magn.)	NiFe (magn.)	NiFe (magn.)	NiFe (magn.)	NiFe (magn.)
Connection		type C	type C	type C	type C	type C
Mounting		clamping	clamping	clamping	clamping	clamping

FSO = Full Scale Output

<sup>1)</sup> Valid with reference controller, relates to standard measuring range

<sup>2)</sup> RMS value of the signal noise

<sup>3)</sup> Non condensing

<sup>4)</sup> Titanium version available

<sup>5)</sup> Sensor mounted in the mid of clamping area

## Sensors

The sensors are designed as guard ring capacitors. They are connected to the signal conditioning electronics with a triaxial cable. The sensor cable is connected to the sensor using a high quality connector. All standard sensors can be used within a maximum deviation of 0.3 % without recalibration. Individually matched special sensors are produced on request.

## Measuring range expansion/reduction

The capaNCDT controller can optionally be configured so that the standard measuring ranges of the sensors are reduced by half or expanded by the factor of 2. The reduction increases the accuracy while the measuring range expansion reduces the accuracy.

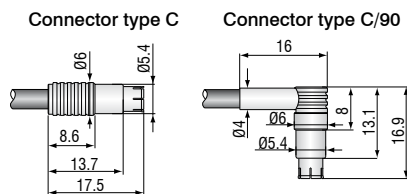



Sensor type		CS1	CS1HP	CSE1	CSE1,25	CS2	CSE2
Article No.		6610054	6610074	6610103	6610161	6610052	6610104
Measuring range	reduced	0.5 mm	0.5 mm	0.5 mm	0.625 mm	1 mm	1 mm
	nominal	1 mm	1 mm	1 mm	1.25 mm	2 mm	2 mm
	extended	2 mm	2 mm	2 mm	2.5 mm	4 mm	4 mm
Linearity <sup>1)</sup>		$\leq \pm 1.5 \mu\text{m}$	$\leq \pm 1.5 \mu\text{m}$	$\leq \pm 1 \mu\text{m}$	$\leq \pm 1.25 \mu\text{m}$	$\leq \pm 1 \mu\text{m}$	$\leq \pm 2 \mu\text{m}$
		$\leq \pm 0.15 \% \text{ FSO}$	$\leq \pm 0.15 \% \text{ FSO}$	$\leq \pm 0.1 \% \text{ FSO}$	$\leq \pm 0.1 \% \text{ FSO}$	$\leq \pm 0.05 \% \text{ FSO}$	$\leq \pm 0.1 \% \text{ FSO}$
Resolution <sup>1) 2)</sup>	static 2 Hz	0.75 nm	0.75 nm	0.75 nm	0.9 nm	1.5 nm	1.5 nm
	dynamic 8.5 kHz	20 nm	20 nm	20 nm	25 nm	40 nm	40 nm
Temperature stability	Zero <sup>5)</sup>	-170 nm/K	-60 nm/K	-60 nm/K	-65 nm/K	-170 nm/K	-170 nm/K
	Sensitivity	-32 nm/K	-10 nm/K	-10 nm/K	-50 nm/K	-64 nm/K	-64 nm/K
Temperature range	Operation	-50 ... +200 °C	-50 ... +200 °C	-50 ... +200 °C	-50 ... +200 °C	-50 ... +200 °C	-50 ... +200 °C
	Storage	-50 ... +200 °C	-50 ... +200 °C	-50 ... +200 °C	-50 ... +200 °C	-50 ... +200 °C	-50 ... +200 °C
Humidity <sup>3)</sup>		0 % ... 95 % r.H.	0 % ... 95 % r.H.	0 % ... 95 % r.H.	0 % ... 95 % r.H.	0 % ... 95 % r.H.	0 % ... 95 % r.H.
Dimensions		$\varnothing 10 \times 21 \text{ mm}$	$\varnothing 10 \times 20 \text{ mm}$	$\varnothing 8 \times 12 \text{ mm}$	$\varnothing 10 \times 22 \text{ mm}$	$\varnothing 20 \times 24 \text{ mm}$	$\varnothing 14 \times 22 \text{ mm}$
Active measuring area		$\varnothing 5.7 \text{ mm}$	$\varnothing 5.7 \text{ mm}$	$\varnothing 5.7 \text{ mm}$	$\varnothing 6.5 \text{ mm}$	$\varnothing 7.9 \text{ mm}$	$\varnothing 8.0 \text{ mm}$
Guard ring width		1.5 mm	1.5 mm	0.9 mm	1.6 mm	4.4 mm	2.7 mm
Minimum target diameter		$\varnothing 9 \text{ mm}$	$\varnothing 9 \text{ mm}$	$\varnothing 8 \text{ mm}$	$\varnothing 10 \text{ mm}$	$\varnothing 17 \text{ mm}$	$\varnothing 14 \text{ mm}$
Weight		8 g	8 g	3.5 g	8.2 g	50 g	20 g
Material	Housing	1.4404 <sup>4)</sup> (non-magn.)	NiFe (magn.)	NiFe (magn.)	1.4404 (non-magn.)	1.4404 <sup>4)</sup> (non-magn.)	1.4404 (non-magn.)
Connection		type B	type B	type C	type B	type B	type B
Mounting		clamping	clamping	clamping	clamping	clamping	clamping

FSO = Full Scale Output

<sup>1)</sup> Valid with reference controller, relates to standard measuring range

<sup>2)</sup> RMS value of the signal noise

<sup>3)</sup> Non condensing

<sup>4)</sup> Titanium version available

<sup>5)</sup> Sensor mounted in the mid of clamping area

### Mounting cylindrical sensors

All sensors can be installed as both freestanding and flush units.

The sensors can be clamped or fastened using a collet.

Connector type B

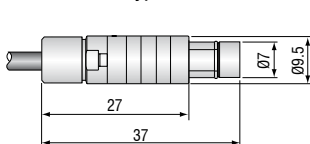

Connector type B/90

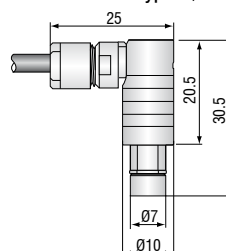

Mounting with set screw (plastic)

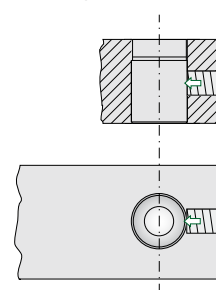

Mounting with collet

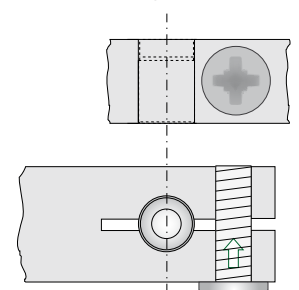

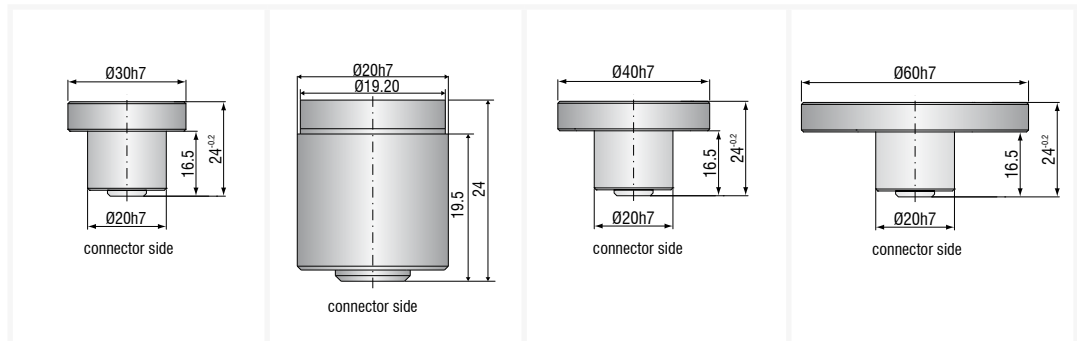

Sensor type		CS3	CSE3	CS5	CS10
Article No.		6610055	6610170	6610056	6610057
Measuring range	reduced	1.5 mm	1.5 mm	2.5 mm	5 mm
	nominal	3 mm	3 mm	5 mm	10 mm
	extended	6 mm	6 mm	10 mm	20 mm
Linearity <sup>1)</sup>		$\leq \pm 0.9 \mu\text{m}$	$\leq \pm 3 \mu\text{m}$	$\leq \pm 2.5 \mu\text{m}$	$\leq \pm 15 \mu\text{m}$
		$\leq \pm 0.03 \% \text{ FSO}$	$\leq \pm 0.1 \% \text{ FSO}$	$\leq \pm 0.05 \% \text{ FSO}$	$\leq \pm 0.15 \% \text{ FSO}$
Resolution <sup>1) 2)</sup>	static 2 Hz	2.25 nm	2.25 nm	3.75 nm	7.5 nm
	dynamic 8.5 kHz	60 nm	60 nm	100 nm	200 nm
Temperature stability	Zero <sup>5)</sup>	-170 nm/K	-95 nm/K	-170 nm/K	-170 nm/K
	Sensitivity	-96 nm/K	-85 nm/K	-160 nm/K	-320 nm/K
Temperature range	Operation	-50 ... +200 °C	-50 ... +200 °C	-50 ... +200 °C	-50 ... +200 °C
	Storage	-50 ... +200 °C	-50 ... +200 °C	-50 ... +200 °C	-50 ... +200 °C
Humidity <sup>3)</sup>		0 % ... 95 % r.H.	0 % ... 95 % r.H.	0 % ... 95 % r.H.	0 % ... 95 % r.H.
Dimensions		Ø30 × 24 mm	Ø20 × 24 mm	Ø40 × 24 mm	Ø60 × 24 mm
Active measuring area		Ø9.8 mm	Ø10 mm	Ø12.6 mm	Ø17.8 mm
Guard ring width		8 mm	4.6 mm	11.6 mm	19 mm
Minimum target diameter		Ø27 mm	Ø20 mm	Ø37 mm	Ø57 mm
Weight		70 g	50 g	95 g	180 g
Material	Housing	1.4404 (non-magn.)	1.4404 (non-magn.)	1.4404 <sup>4)</sup> (non-magn.)	1.4404 <sup>4)</sup> (non-magn.)
Connection		type B	type B	type B	type B
Mounting		clamping	clamping	clamping	clamping

FSO = Full Scale Output

<sup>1)</sup> Valid with reference controller, relates to standard measuring range

<sup>2)</sup> RMS value of the signal noise

<sup>3)</sup> Non condensing

<sup>4)</sup> Titanium version available

<sup>5)</sup> Sensor mounted in the mid of clamping area

Connector type B

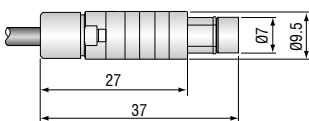

Connector type B/90

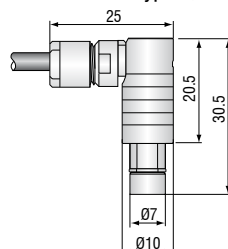

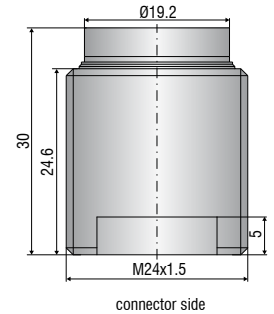
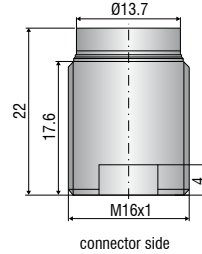
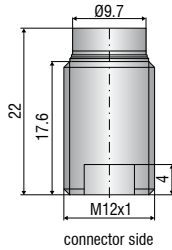
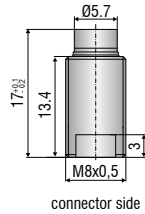

Sensor type		CSE05/M8	CSE1,25/M12	CSE2/M16	CSE3/M24
Article No.		6610172	6610160	6610167	6610171
Measuring range	reduced	0.25 mm	0.625 mm	1 mm	1.5 mm
	nominal	0.5 mm	1.25 mm	2 mm	3 mm
	extended	1 mm	2.5 mm	4 mm	6 mm
Linearity <sup>1)</sup>		$\leq \pm 0.5 \mu\text{m}$	$\leq \pm 1.25 \mu\text{m}$	$\leq \pm 2 \mu\text{m}$	$\leq \pm 3 \mu\text{m}$
		$\leq \pm 0.1 \%$ FSO	$\leq \pm 0.1 \%$ FSO	$\leq \pm 0.1 \%$ FSO	$\leq \pm 0.1 \%$ FSO
Resolution <sup>1) 2)</sup>	static, 2 Hz	approx. 0.375 nm	approx. 0.95 nm	approx. 1.5 nm	approx. 2.25 nm
	dynamic, 8.5 kHz	approx. 10 nm	approx. 25 nm	approx. 40 nm	approx. 60 nm
Temperature stability <sup>3)</sup>	Zero <sup>4)</sup>	-10 nm/K	-65 nm/K	-65 nm/K	-75 nm/K
	Sensitivity	-5 nm/K	-50 nm/K	-80 nm/K	-85 nm/K
Temperature range	Operation	-50 ... +200 °C	-50 ... +200 °C	-50 ... +200 °C	-50 ... +200 °C
	Storage	-50 ... +200 °C	-50 ... +200 °C	-50 ... +200 °C	-50 ... +200 °C
Humidity <sup>5)</sup>		0 ... 95 % r.H.	0 ... 95 % r.H.	0 ... 95 % r.H.	0 ... 95 % r.H.
Dimensions		Ø8 x 17 mm	Ø12 x 22 mm	Ø16 x 22 mm	Ø24 x 30 mm
Active measuring area		Ø 3.9 mm	Ø 6.3 mm	Ø 8.0 mm	Ø 9.8 mm
Guard ring width		0.8 mm	1.6 mm	2.7 mm	4.6 mm
Minimum target diameter		Ø6 mm	Ø10 mm	Ø14 mm	Ø20 mm
Weight		3.5 g	11.5 g	35 g	80 g
Material	Housing	NiFe (magn.)	1.4404 (non-magn.)	1.4404 (non-magn.)	1.4404 (non-magn.)
Connection		type C	type B	type B	type B
Mounting		Thread M8x0.5	Thread M12x1	Thread M16x1	Thread M24x1.5
Distance from the sensor surface for the recommended mounting option		3.6 mm	4.4 mm	4.4 mm	5.4 mm

FSO = Full Scale Output

<sup>1)</sup> Valid with reference controller, relates to standard measuring range

<sup>2)</sup> RMS value of the signal noise

<sup>3)</sup> from more than +140°C: non-linear signal drift

<sup>4)</sup> with recommended mounting option

<sup>5)</sup> non-condensing

### Installing thread sensors

Please refer to the operating instructions for the tightening torque.

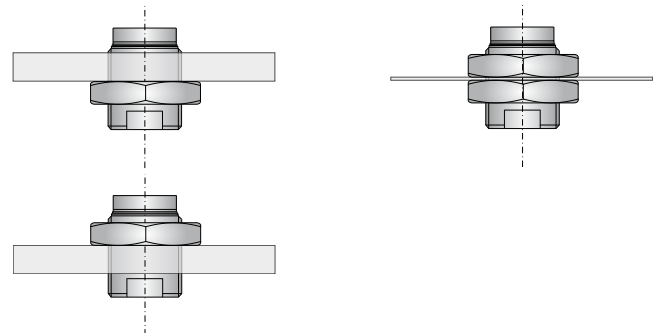
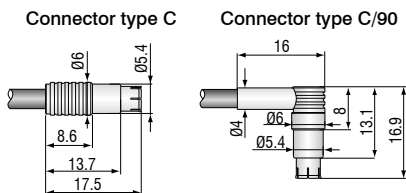

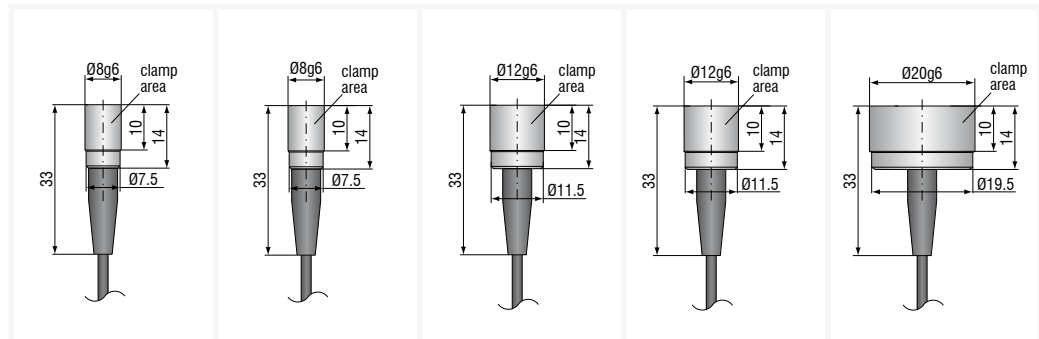

Sensor type		CSH02-CAM1,4	CSH05-CAM1,4	CSH1-CAM1,4	CSH1,2-CAM1,4	CSH2-CAM1,4
Article No.		6610086	6610087	6610088	6610089	6610107
Measuring range	reduced	0.1 mm	0.25 mm	0.5 mm	0.6 mm	1 mm
	nominal	0.2 mm	0.5 mm	1 mm	1.2 mm	2 mm
	extended	0.4 mm	1 mm	2 mm	2.4 mm	4 mm
Linearity <sup>1)</sup>		$\leq \pm 0.054 \mu\text{m}$	$\leq \pm 0.13 \mu\text{m}$	$\leq \pm 0.13 \mu\text{m}$	$\leq \pm 0.84 \mu\text{m}$	$\leq \pm 0.5 \mu\text{m}$
		$\leq \pm 0.027 \% \text{ FSO}$	$\leq \pm 0.026 \% \text{ FSO}$	$\leq \pm 0.013 \% \text{ FSO}$	$\leq \pm 0.07 \% \text{ FSO}$	$\leq \pm 0.025 \% \text{ FSO}$
Resolution <sup>1) 2)</sup>	static 2 Hz	0.15 nm	0.38 nm	0.75 nm	0.9 nm	1.5 nm
	dynamic 8.5 kHz	4 nm	10 nm	20 nm	24 nm	40 nm
Temperature stability	Zero <sup>5)</sup>	-19 nm/K	-19 nm/K	-19 nm/K	-19 nm/K	-19 nm/K
	Sensitivity	-2.4 nm/K	-6 nm/K	-12 nm/K	-14.4 nm/K	-24 nm/K
Temperature range	Operation	-50 ... +200 °C	-50 ... +200 °C	-50 ... +200 °C	-50 ... +200 °C	-50 ... +200 °C
	Storage	-50 ... +200 °C	-50 ... +200 °C	-50 ... +200 °C	-50 ... +200 °C	-50 ... +200 °C
Humidity <sup>3)</sup>		0 % ... 95 % r.H.	0 % ... 95 % r.H.	0 % ... 95 % r.H.	0 % ... 95 % r.H.	0 % ... 95 % r.H.
Dimensions <sup>4)</sup>		Ø8 × 14 mm	Ø8 × 14 mm	Ø12 × 14 mm	Ø12 × 14 mm	Ø20 × 14 mm
Active measuring area		Ø2.6 mm	Ø4.1 mm	Ø5.7 mm	Ø6.3 mm	Ø8.1 mm
Guard ring width		1.9 mm	1.2 mm	2.4 mm	2.1 mm	4.4 mm
Minimum target diameter		Ø7 mm	Ø7 mm	Ø11 mm	Ø11 mm	Ø17 mm
Weight (incl. cable and connector)		30 g	30 g	33 g	33 g	38 g
Material	Housing	1.4104 (magn.)	1.4104 (magn.)	1.4104 (magn.)	1.4104 (magn.)	1.4104 (magn.)
Connection	Cable integrated	Ø2.1 mm × 1.4 m axial	Ø2.1 mm × 1.4 m axial	Ø2.1 mm × 1.4 m axial	Ø2.1 mm × 1.4 m axial	Ø2.1 mm × 1.4 m axial
Mounting		clamping	clamping	clamping	clamping	clamping

FSO = Full Scale Output CSH Sensors are matched to controller with standard cable length

<sup>1)</sup> Valid with reference controller, relates to standard measuring range

<sup>2)</sup> RMS value of the signal noise

<sup>3)</sup> Non condensing

<sup>4)</sup> Without cable, bend protection and crimp

<sup>5)</sup> In the case of a sensor mounting 2 mm behind front surface

### Mounting cylindrical sensors

All sensors can be installed as both freestanding and flush units.

The sensors can be clamped or fastened using a collet.

#### Mounting with set screw (plastic)

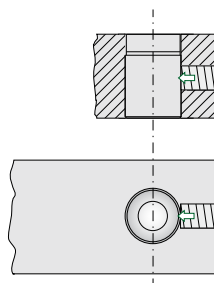

#### Mounting with collet

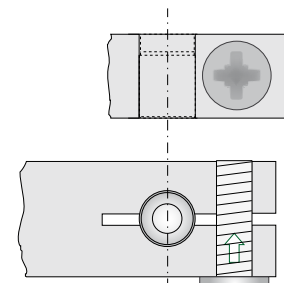

### Important!

All Micro-Epsilon sensors are short circuit proof. Unlike other systems the pre-amplifier will not get damaged, if the front face of the sensor gets shorted by touching the conductive target.



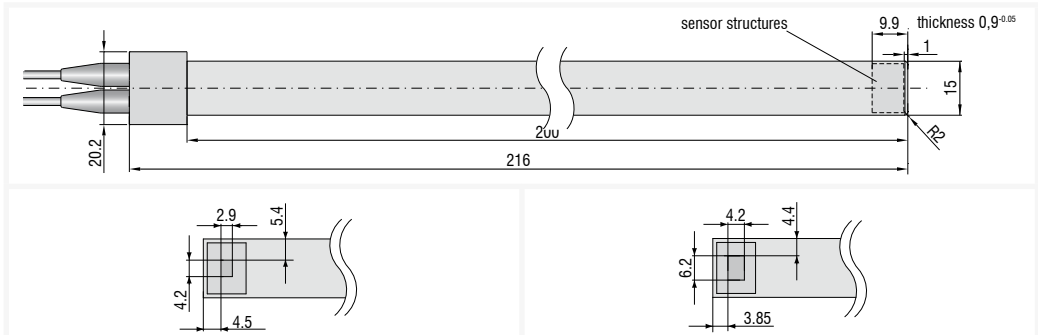

Sensor type		CSG0,50-CAm2,0	CSG1,00-CAm2,0
Article No.		6610112	6610111
Measuring range	Standard	0.5 mm	1 mm
Gap width <sup>1)</sup>		0.9 ... 1.9 mm	0.9 ... 2.9 mm
Linearity <sup>2)</sup>		≤ ±0.5 μm	≤ ±1 μm
Resolution <sup>2),3)</sup>	static 2 Hz	4 nm	8 nm
	dynamic 8.5 kHz	90 nm	180 nm
Temperature stability	Zero	-50 nm/K	-50 nm/K
	Sensitivity	-20 nm/K	-40 nm/K
Temperature range	Operation	-50 ... +100 °C	-50 ... +100 °C
	Storage	-50 ... +100 °C	-50 ... +100 °C
Humidity <sup>3)</sup>		0 ... 95 %	0 ... 95 %
Dimensions (without housing)		200 x 15 x 0.9 mm	200 x 15 x 0.9 mm
Active measuring area		3 x 4.3 mm	4.2 x 5.1 mm
Guard ring width		2.7 mm	2.2 mm
Minimum target diameter		approx. 7 x 8 mm	approx. 8 x 9 mm
Weight		77 g	77 g
Material	Housing	1.4301	1.4301
	Sensor	FR4	FR4
Connection	Cable integrated	2 m	2 m

<sup>1)</sup> Sensor width + measuring range on both sides

<sup>2)</sup> RMS value of the signal noise

<sup>3)</sup> Valid with controller DT6530

<sup>4)</sup> Non condensing

Connector type B

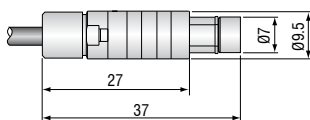

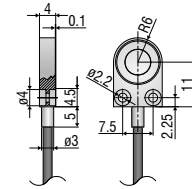
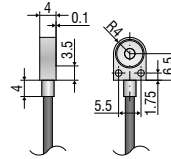
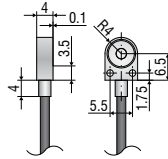

Sensor type		CSH02FL-CRm1,4	CSH05FL-CRm1,4	CSH1FL-CRm1,4
Article No.		6610075	6610085	6610072
Measuring range	reduced	0.1 mm	0.25 mm	0.5 mm
	nominal	0.2 mm	0.5 mm	1 mm
	extended	0.4 mm	1 mm	2 mm
Linearity <sup>1)</sup>		$\leq \pm 0.05 \mu\text{m}$	$\leq \pm 0.09 \mu\text{m}$	$\leq \pm 0.2 \mu\text{m}$
		$\leq \pm 0.025 \% \text{ FSO}$	$\leq \pm 0.018 \% \text{ FSO}$	$\leq \pm 0.02 \% \text{ FSO}$
Resolution <sup>1) 2)</sup>	static 2 Hz	0.15 nm	0.38 nm	0.75 nm
	dynamic 8.5 kHz	4 nm	10 nm	20 nm
Temperature stability	Zero <sup>5)</sup>	-37.6 or 2.4 nm/°C	-37.6 or 2.4 nm/°C	-37.6 or 2.4 nm/°C
	Sensitivity	-2.4 nm/K	-6 nm/K	-12 nm/K
Temperature range	Operation	-50... +200 °C	-50... +200 °C	-50... +200 °C
	Storage	-50... +200 °C	-50... +200 °C	-50... +200 °C
Humidity <sup>3)</sup>		0 % ... 95 % r.H.	0 % ... 95 % r.H.	0 % ... 95 % r.H.
Dimensions <sup>4)</sup>		10.5 × 8 × 4 mm	10.5 × 8 × 4 mm	17 × 12 × 4 mm
Active measuring area		Ø2.6 mm	Ø4.1 mm	Ø5.7 mm
Guard ring width		1.9 mm	1.2 mm	2.4 mm
Minimum target diameter		Ø7 mm	Ø7 mm	Ø11 mm
Weight (incl. cable and connector)		28 g	28 g	30 g
Material	Housing	1.4104 (magn.)	1.4104 (magn.)	1.4104 (magn.)
Connection	Cable integrated	Ø2.1 mm × 1.4 m radial	Ø2.1 mm × 1.4 m radial	Ø2.1 mm × 1.4 m radial
Mounting		2x thread M2	2x thread M2	2x screw M2 DIN 84A

FSO = Full Scale Output CSH Sensors are matched to controller with standard cable length

<sup>1)</sup> Valid with reference controller, relates to standard measuring range

<sup>2)</sup> RMS value of the signal noise

<sup>3)</sup> Non condensing

<sup>4)</sup> Without cable, bend protection and crimp

<sup>5)</sup> In the case of a sensor mounting on the top or underside

### Mounting flat sensors

The flat sensors are attached using a threaded bore for M2 (for the sensors CSH02FL and CSH05FL) or using a through-hole for M2 bolts. The sensors can be bolted on top or below.

#### Screw connection from above on the underside

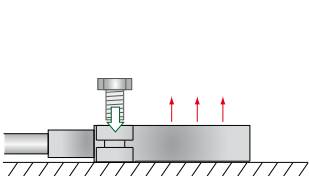

#### Screw connection from below on the sensor top side

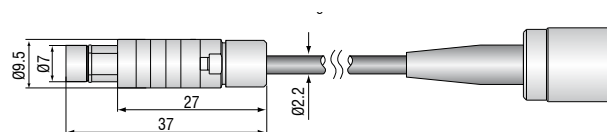
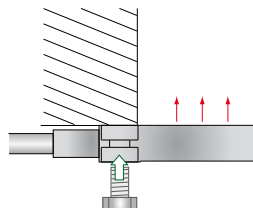

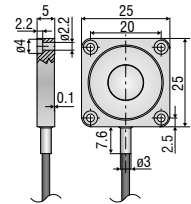
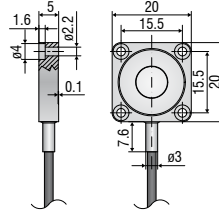
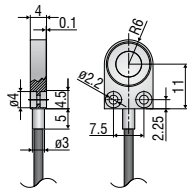

Sensor type		CSH1,2FL-CRm1,4	CSH2FL-CRm1,4	CSH3FL-CRm1,4
Article No.		6610077	6610094	6610140
Measuring range	reduced	0.6 mm	1 mm	1.5 mm
	nominal	1.2 mm	2 mm	3 mm
	extended	2.4 mm	4 mm	6 mm
Linearity <sup>1)</sup>		0.84 $\mu$ m	0.32 $\mu$ m	$\leq \pm 0.9 \mu$ m
		0.07 % FSO	0.016 % FSO	$\leq \pm 0.03$ % FSO
Resolution <sup>1) 2)</sup>	static 2 Hz	0.9 nm	1.5 nm	2.25 nm
	dynamic 8.5 kHz	24 nm	40 nm	60 nm
Temperature stability	Zero <sup>5)</sup>	-37.6 or 2.4 nm/ $^{\circ}$ C	-47 or 4 nm/K	-50 nm/K
	Sensitivity	-14.4 nm/K	-24 nm/K	-40 nm/K
Temperature range	Operation	-50...+200 $^{\circ}$ C	-50...+200 $^{\circ}$ C	-50...+200 $^{\circ}$ C
	Storage	-50...+200 $^{\circ}$ C	-50...+200 $^{\circ}$ C	-50...+200 $^{\circ}$ C
Humidity <sup>3)</sup>		0 ... 95 % r.H.	0 ... 95 % r.H.	0 ... 95 % r.H.
Dimensions <sup>4)</sup>		17 $\times$ 12 $\times$ 4 mm	20 $\times$ 20 $\times$ 5 mm	25 $\times$ 25 $\times$ 5 mm
Active measuring area		$\varnothing$ 6.3 mm	$\varnothing$ 8.1 mm	$\varnothing$ 10 mm
Guard ring width		2.1 mm	4.4 mm	7.8 mm
Minimum target diameter		$\varnothing$ 11 mm	$\varnothing$ 17 mm	$\varnothing$ 24 mm
Weight (incl. cable and connector)		30 g	36 g	37 g
Material	Housing	1.4104 (magn.)	1.4104 (magn.)	1.4104 (magn.)
Connection	Cable integrated	$\varnothing$ 2.1 mm $\times$ 1.4 m radial	$\varnothing$ 2.1 mm $\times$ 1.4 m radial	$\varnothing$ 2.1 mm $\times$ 1.4 m radial
Mounting		2x screw M2 DIN 84A	4x screw M2 DIN 84A	4x screw M2 DIN 84A

FSO = Full Scale Output CSH Sensors are matched to controller with standard cable length

<sup>1)</sup> Valid with reference controller, relates to standard measuring range

<sup>2)</sup> RMS value of the signal noise

<sup>3)</sup> Non condensing

<sup>4)</sup> Without cable, bend protection and crimp

<sup>5)</sup> In the case of a sensor mounting on the top or underside



- Multi-channel system with sub-nanometer precision resolution
- Virtually independent of temperature
- Also measures against insulators
- As benchtop unit and as card carrier for a 19-inch format
- Integrated calculation function for thickness measurements
- Numerous filters, averaging, trigger functions, measured value storage, digital linearization

### System design

The capaNCDT 6500 can be used for multi-channel operation and is modular in its design. Up to eight sensors can be connected to the signal conditioning electronics (Euro-size cards) via a preamplifier module.

For the DL6530 version, the pre-amplifier is integrated in the housing and is used for cable lengths up to 4 m (with CC cable) or 8 m (with CCg cable). For longer cable lengths, the external preamplifiers CP6001 or CPM6011 are used.

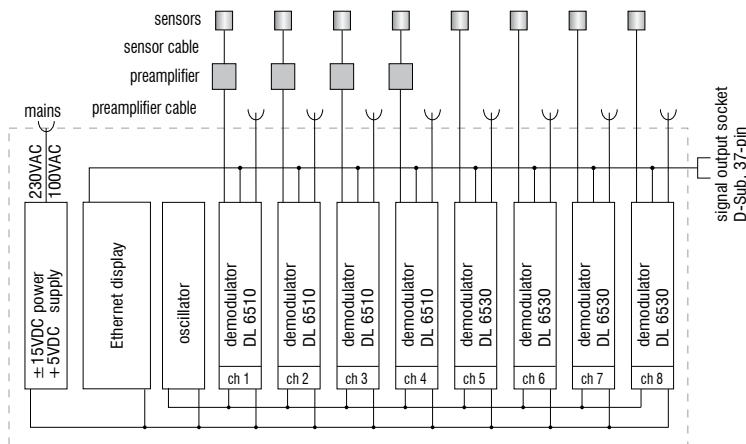

### A measuring system with n measurement channels consists of:

1. controller DT6530 with power supply, display, Ethernet, oscillator and analog output
2. n x demodulator modules DL6510 (DL6530 with integral pre-amplifier)
3. n x pre-amplifier connecting cables
4. n x pre-amplifier modules CP6001
5. n x sensor cables
6. n x sensors

DL6510: One item of position 2 to 6 is needed for each channel.

DL6530: One item of position 2, 5 and 6 is needed for each channel.

**Web interface**

The web interface for controller configuration opens via Ethernet.  
Up to 8 channels can be visualized and linked arithmetically.

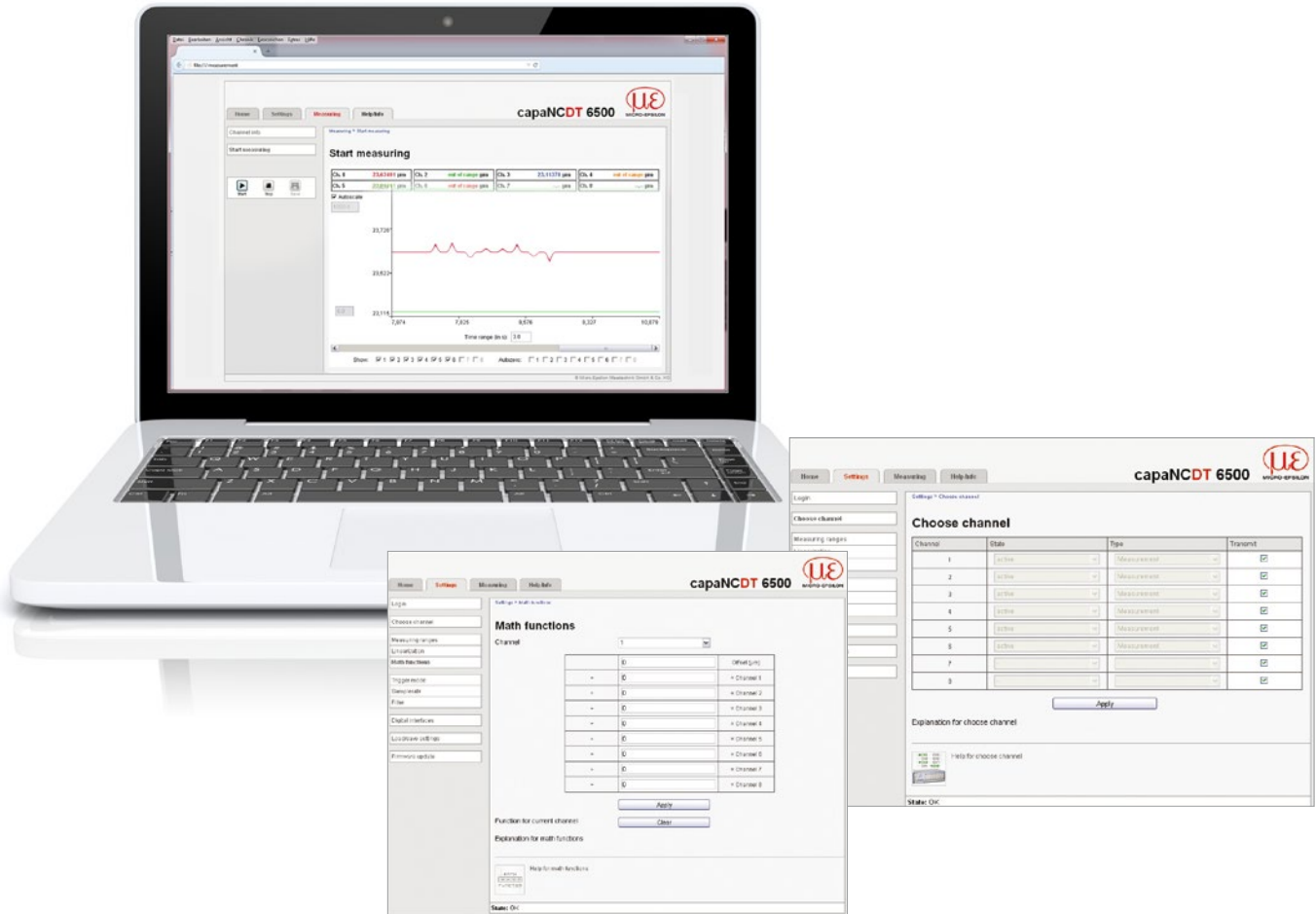

**System configuration**

**System capaNCDT 6500 (with integral pre-amplifier):**

- DT6530 / DT6530C Rack
- Demodulator DL6530
- Sensor cable
- Sensor



**CPM6011**  
External pre-amplifier for standard measurements



**CP6001**  
External pre-amplifier for high precision measurements

**System capaNCDT 6510 (with external pre-amplifier):**

- DT6530 / DT6530C Rack
- Demodulator DL6510
- Sensor cable
- Sensor
- Pre-amplifier CPM6011 / CP6001
- Pre-amplifier cable



**DT6530C 2 channel rack**



**DT6530 8 channel rack**

Controller DT6530 8-channel rack

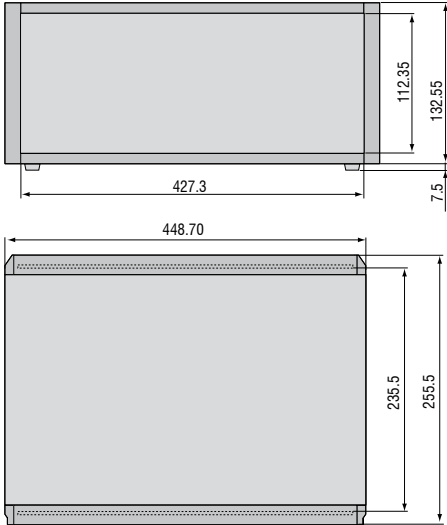

Controller DT6530C 2-channel rack

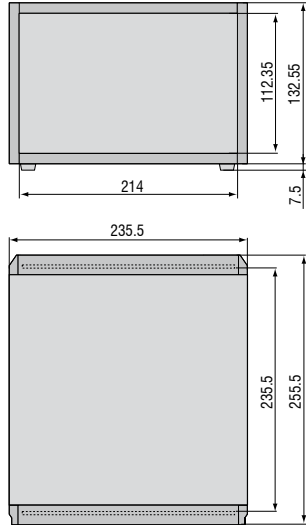

CPM6011 capacitive pre-amplifier

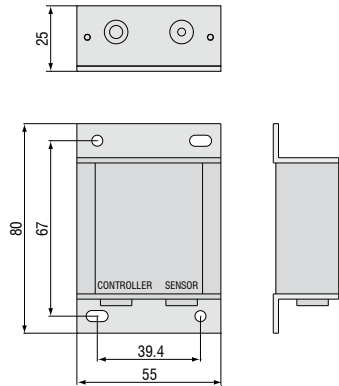

DL6530/6510 front cover

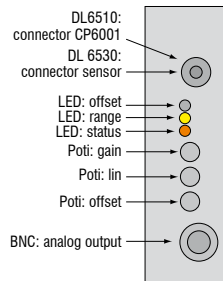

CP6001 capacitive pre-amplifier

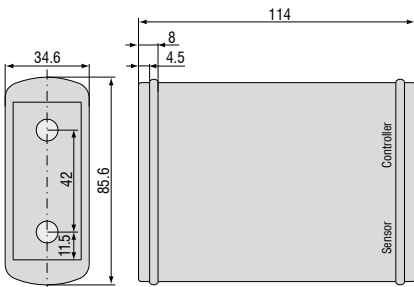

Mounting adapter CP6001

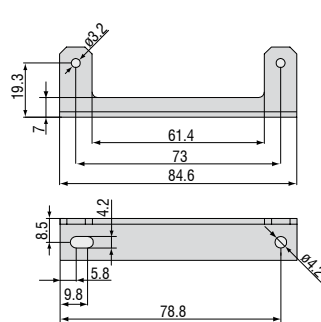

Pre-amplifier cable CA5 / CAx

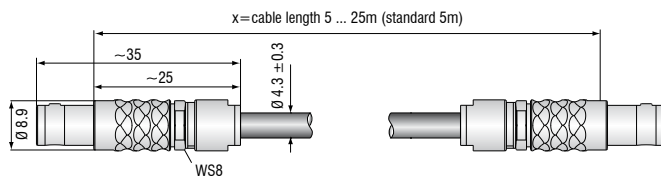

Controller type	DT6530	DT6530 with pre-amplifier CPM6011
Resolution static <sup>1)</sup>	0.000075 % FSO	0.0006 % FSO
Resolution dynamic <sup>1)</sup>	0.002 % FSO (8.5 kHz)	0.015 % FSO (8.5kHz)
Data rate analog output	8.5 kHz (-3 dB)	8.5 kHz (-3 dB)
Bandwidth (switchable)	20 Hz; 1 kHz; 8.5 kHz	20 Hz; 1 kHz; 8.5 kHz
Data rate digital output	4 x 7.8 kSa/s; 8 x 3.9 kSa/s	4 x 7.8 kSa/s; 8 x 3.9 kSa/s
Linearity (typ.)	≤ ±0.025 % FSO	≤ ±0.05 % FSO
Max. sensitivity deviation	≤ ±0.05 % FSO	≤ ±0.1 % FSO
Repeatability	0.0003 % FSO	0.001 % FSO
Long-term stability	±0.002 % FSO / month	±0.02 % FSO / month
Synchronous operation	yes	yes
Insulator measurement	yes	no
Temperature stability	±digital: 5 ppm/°C analog: 10 ppm/°C	80 ppm
Temperature range (during operation)	Sensor	-50 ... + 200 °C
	Controller	+10 ... +60 °C
Temperature range (storage)	-10 ... +75 °C	-10 ... +75 °C
Supply	230 VAC	230 VAC
Output	0 ... 10 V (max. 10 mA short circuit proof);	0 ... 10 V (max. 10 mA short circuit proof);
	4 ... 20 mA (load max. 500 Ω)	4 ... 20 mA (load max. 500 Ω)
	optional: 0 ... 20 mA (load max. 500 Ω)	optional: 0 ... 20 mA (load max. 500 Ω)
	Ethernet 24 Bit; EtherCAT	Ethernet 24 Bit; EtherCAT
Sensors	suitable for all sensors	suitable for all sensors
Sensor cable standard	CC cable ≤ 1 m CCm cable = 1.4 m CCg cable = 2 m	CC cable ≤ 1 m CCm cable = 1.4 m CCg cable = 2 m
Sensor cable (special tuning)	double / triple / quadruple standard cable length	double / triple / quadruple standard cable length
Trigger	TTL, 5 V	TTL, 5 V
No. of channels	max. 8	max. 8

FSO = Full Scale Output

<sup>1)</sup> RMS noise related to mid of measuring range

Options		
Article number	Description	Description
2982011	EMR2 CP6001	extended measuring range (factor: 2) in combination with DL6510
2982013	RMR 1/2 CP6001	reduced measuring range (factor: 1/2) in combination with DL6510
2982015	ECL2 CP6001	special tuning for double standard cable length in combination with DL6510
2982017	ECL3 CP6001	special tuning for triple standard cable length in combination with DL6510
2982026	ECL4 CP6001	special tuning for quadruple standard cable length in combination with DL6510
2982028	ECL2 CPM6011	special tuning for 2 m sensor cable in combination with DL6510
2982019	EMR2 DL65x0	extended measuring range (factor: 2)
2982020	RMR 1/2 DL65x0	reduced measuring range (factor: 1/2)
2982021	ECL2 DL65x0	special tuning for double standard cable length
2982023	ECL3 DL65x0	special tuning for triple standard cable length
2982025	ECL4 DL65x0	special tuning for 4 m sensor cable
2982033	EMR2 CPM6011	extended measuring range (factor: 2)



- Modular, expandable for up to 4 channels
- Ethernet / EtherCAT interface
- Easy configuration using the web browser
- Resolution up to 0.0005 % FSO
- Bandwidth: up to 20 kHz
- Digital data rate: 4 x 3.9 kSa/s
- Trigger feature
- Synchronous operation supported

**System design**

The new capaNCDT 6200 is a modular measuring system that offers excellent performance at a very attractive price. A modular design enables the system to be expanded at any time by up to four measuring channels. The measuring system includes a control unit and a demodulator for each sensor. The Ethernet interface integrated in the controller enables fast, easy configuration via web browser. The DL6230 demodulator provides high resolution measurements. The capaNCDT 6222 is used for high speed measurements up to 20 kHz. The compact controller can be used as a benchtop unit, wall-mounted unit or DIN rail-mounted via an adapter. The capaNCDT 6200 is compatible with all sensor models from Micro-Epsilon.



**Web interface**

The web interface for controller configuration opens via Ethernet. Up to 4 channels can be visualized and linked arithmetically.

**A measuring system consists of:**

- Control unit DT62xx
- Demodulator DL62xx
- Sensor
- Sensor cable
- Power supply cable
- Ethernet cable EtherCAT cable
- Signal output cable

**Accessories:**

- Signal output cable
- Power supply cable
- DIN rail brackets
- mounting plates for wall mounting

**Block diagram**

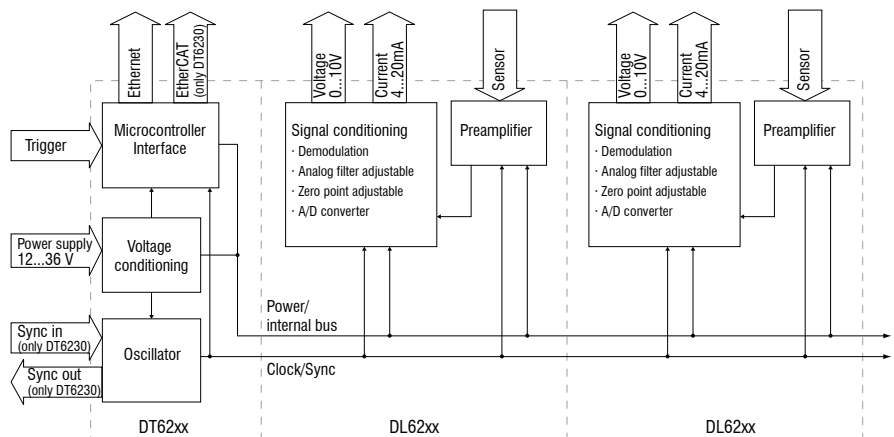



Controller type DT62x0		Demodulator DL6220	Demodulator DL6230
Resolution static <sup>1)</sup>		0.004 % FSO	0.0005 % FSO
Resolution dynamic <sup>1)</sup>		0.02 % FSO (5 kHz)	0.005 % FSO (5 kHz)
Bandwidth		5 kHz (-3 dB)	5 kHz (-3 dB)
Bandwidth (switchable)		5 kHz, 20 Hz	5 kHz, 20 Hz
Data rate digital output		max. 3.906 kSa/s	max. 3.906 kSa/s
Linearity (typ.)		≤ ±0.05 % FSO	≤ ±0.025 % FSO
Sensitivity deviation		≤ ±0.1 % FSO	≤ ±0.1 % FSO
Long-term stability		≤ 0.02 % FSO/month	≤ 0.02 % FSO/month
Synchronous operation supported	DT6220	yes (only internal)	yes (only internal)
	DT6230	yes	yes
Insulator measurement		no	no
Temperature stability		200 ppm	200 ppm
Temperature range (during operation)	Sensor	-50 ... + 200 °C	-50 ... + 200 °C
	Controller	+10 ... +60 °C	+10 ... +60 °C
Temperature range (storage)		-10 ... +75 °C	-10 ... +75 °C
Supply	DT6220	24 VDC (12 ... 36 VDC)	24 VDC (15 ... 36 VDC)
	DT6230	24 VDC (15 ... 36 VDC)	24 VDC (15 ... 36 VDC)
Power consumption	per DL62x0	1.8 W (typ.); 2.0 W (max.)	1.9 W (typ.); 2.2 W (max.)
	DT6220	3.1 W (typ.)	3.1 W (typ.)
	DT6230	3.8 W (typ.)	3.8 W (typ.)
Analog output		0 ... 10 V (short circuit proof)	0 ... 10 V (short circuit proof)
		4 ... 20 mA (load max. 500 Ohm)	4 ... 20 mA (load max. 500 Ohm)
Digital interface	DT6220	Ethernet	Ethernet
	DT6230	Ethernet + EtherCAT	Ethernet + EtherCAT
Sensors		suitable for all sensors	suitable for all sensors
Sensor cable standard		CC cable ≤ 1 m CCm cable = 1.4 m CCg cable = 2 m	CC cable ≤ 1 m CCm cable = 1.4 m CCg cable = 2 m
Sensor cable (special tuning)		double / triple standard cable length	double / triple standard cable length
Trigger		TTL, 5 V	TTL, 5 V
No. of channels		max. 4	max. 4

FSO = Full Scale Output

<sup>1)</sup> RMS noise related to mid of measuring range

Controller type DT6222	Demodulator DL6222	Demodulator DL6222/ECL2
Resolution static <sup>1)</sup>	0.004 % FSO	0.004 % FSO
Resolution dynamic <sup>1)</sup>	0.05 % FSO (20 kHz)	0.1 % FSO (20 kHz)
Bandwidth	20 kHz (-3 dB)	20 kHz (-3 dB)
Bandwidth (switchable)	20 kHz, 20 Hz	20 kHz, 20 Hz
Data rate digital output	max. 3.906 kSa/s	max. 3.906 kSa/s
Linearity (typ.)	≤ ±0.1 % FSO	≤ ±0.2 % FSO
Sensitivity deviation	≤ ±0.1 % FSO	≤ ±0.1 % FSO
Long-term stability	≤ 0.02 % FSO/month	≤ 0.02 % FSO/month
Synchronous operation supported (multiple controllers)	no	no
Insulator measurement	no	no
Temperature stability	200 ppm	200 ppm
Temperature range (during operation)	Sensor -20 ... +200 °C Controller +10 ... +60 °C	-20 ... +200 °C +10 ... +60 °C
Temperature range (storage)	-10 ... +75 °C	-10 ... +75 °C
Supply	24 VDC (12 ... 36 VDC)	24 VDC (12 ... 36 VDC)
Power consumption	DT6222 2.8 W (typ.) per DL6222 1.2 W (typ.); 1.4 W (max.)	2.8 W (typ.) 1.2 W (typ.); 1.4 W (max.)
Analog output	0 ... 10 V (short circuit proof) 4 ... 20 mA (load max. 500 Ω)	0 ... 10 V (short circuit proof) 4 ... 20 mA (load max. 500Ω)
Digital interface	Ethernet	Ethernet
Sensors	suitable for all sensors	suitable for all sensors
Sensor cable standard	CCm1,4x; CCg2,0x	CCm2,8x; CCg4,0x
Sensor cable (special tuning)	≤ 2.8 m (with CCmxx) ≤ 4.0 m (with CCgxx)	≤ 2.8 m (with CCmxx) ≤ 4.0 m (with CCgxx)
Trigger	TTL, 5 V	TTL, 5 V
No. of channels	max. 4	max. 4

FSO = Full Scale Output

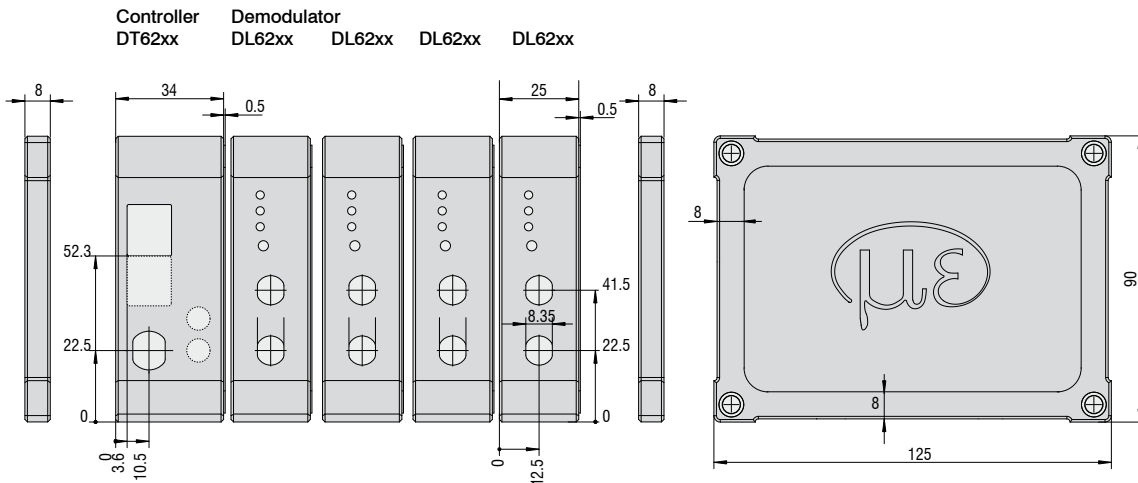
<sup>1)</sup> RMS noise related to mid of measuring range

### Options

Art. No.	Description	Description	Suitable for articles			
			2303018 DL6220	2303022 DL6220/ECL2	2303023 DL6220/ECL3	2303029 DL6220/LC
2982044	LC DL62x0 digital	special calibration of linearity on digital output	○	○	○	●
2982045	LC DL62x0 analog	special calibration of linearity on analog output	○	○	○	●
2982046	ECL2 DL6220	special tuning for double standard cable length (CC = 2 m / CCm = 2.8 m / CCg = 4 m)	-	●	-	●
2982047	ECL3 DL6220	special tuning for triple standard cable length (CC = 3 m / CCm = 4.2 m / CCg = 6 m)	-	-	●	●
2982048	EMR2 DL6220	extended measuring range (factor: 2) contains LC DL62x0 digital and LC DL62x0 analog	○	○	○	●
2982049	RMR1/2 DL6220	reduced measuring range (factor: 1/2) contains LC DL62x0 digital and LC DL62x0 analog	○	○	○	●

Art. No.	Description	Description	Suitable for articles			
			2303019 DL6230	2303024 DL6230/ECL2	2303025 DL6230/ECL3	2303030 DL6230/LC
2982044	LC DL62x0 digital	special calibration of linearity on digital output	○	○	○	●
2982045	LC DL62x0 analog	special calibration of linearity on analog output	○	○	○	●
2982054	ECL2 DL6230	special tuning for double standard cable length (CC = 2 m / CCm = 2.8 m / CCg = 4 m)	-	●	-	●
2982055	ECL3 DL6230	special tuning for triple standard cable length (CC = 3 m / CCm = 4.2 m / CCg = 6 m)	-	-	●	●
2982051	EMR2 DL6230	extended measuring range (factor: 2) contains LC DL62x0 digital and LC DL62x0 analog	○	○	○	●
2982052	EMR3 DL6230	extended measuring range (factor: 3) contains LC DL62x0 digital and LC DL62x0 analog	○	○	○	●
2982053	RMR1/2 DL6230	reduced measuring range (factor: 1/2) contains LC DL62x0 digital and LC DL62x0 analog	○	○	○	●

Art. No.	Description	Description	Suitable for articles		
			2303035 DL6222	2303036 DL6222/ECL2	2303038 DL6222/LC
2982045	LC DL62x0 analog	special calibration of linearity on analog output	○	○	●
2982059	ECL2 DL6222	special tuning for double standard cable length	-	●	●
2982061	EMR2 DL6222	extended measuring range (factor: 2)	○	○	●
2982062	RMR1/2 DL6220	reduced measuring range (factor: 1/2)	○	○	●

- Articles already contain the option
- Option available
- No option available



- Compact and robust construction
- High temperature stability
- Nanometer repeatability
- Suitable for all conductive materials
- 24 V (9 – 36 V) standard power supply for industrial applications
- Ideal for OEM applications
- Suitable for practically all sensors

#### System design

The capaNCDT 6110 single channel capacitive electronics is compatible with all Micro-Epsilon capacitive sensor ranges. The analog measuring system stands out due to its compact design together with high performance. Due to the miniaturized design and its ease of use, the capaNCDT 6120 is ideally suited to integration in machines and facilities. The flexible 9-36 V power supply, enables the capaNCDT 6110 series to also be used in mobile applications. The capaNCDT 6110 stands out due to its excellent price/performance ratio, which makes it particularly suitable for high volume applications.

#### A measuring system consists of:

- Capacitive displacement sensor
- Sensor cable
- Controller
- Supply and signal output cable

#### Accessories:

- Power supply

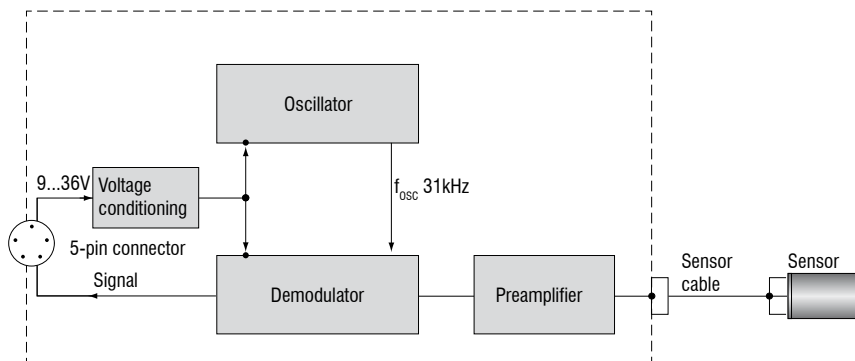

Controller type	DT6110	DT6110/ECL2	DT6112
Resolution static <sup>1)</sup>	0.01 % FSO	0.01 % FSO	0.01 % FSO
Resolution dynamic <sup>1)</sup>	0.015 % FSO (1 kHz)	0.015 % FSO (1 kHz)	0.03 % FSO (20 kHz)
Bandwidth	1 kHz (-3 dB)	1 kHz (-3 dB)	20 kHz (-3 dB)
Linearity (typ.)	≤ ±0.05 % FSO	≤ ±0.05 % FSO	≤ ±0.1 % FSO
Sensitivity deviation	≤ ±0.1 % FSO	≤ ±0.1 % FSO	≤ ±0.1 % FSO
Long-term stability	< 0.05 % FSO/month	< 0.05 % FSO/month	< 0.05 % FSO/month
Synchronous operation	no	no	no
Insulator measurement	no	no	no
Temperature stability	200 ppm	200 ppm	200 ppm
Temperature range (during operation)	Sensor	-50 ... +200 °C	-50 ... +200 °C
	Controller	+10 ... +60 °C	+10 ... +60 °C
Temperature range (storage)	-10 ... +75 °C	-10 ... +75 °C	-10 ... +75 °C
Supply	24 VDC/55 mA (9 - 36 V)	24 VDC/55 mA (9 - 36 V)	24 VDC/55 mA (9 - 36 V)
Output	0 ... 10 V (short-circuit-proof), optional: ±5 V, 10 ... 0 V	0 ... 10 V (short-circuit-proof), optional: ±5 V, 10 ... 0 V	0 ... 10 V (short-circuit-proof), optional: ±5 V, 10 ... 0 V
Sensors	suitable for all sensors	suitable for all sensors	suitable for all sensors
Sensor cable	CC cable ≤ 1 m CCm cable = 1.4 m CCg cable = 2 m	CC cable ≤ 2 m CCm cable = 2.8 m CCg cable = 4 m	CC cable ≤ 1 m CCm cable = 1.4 m CCg cable = 2 m

FSO = Full Scale Output

<sup>1)</sup> RMS noise related to mid of measuring range

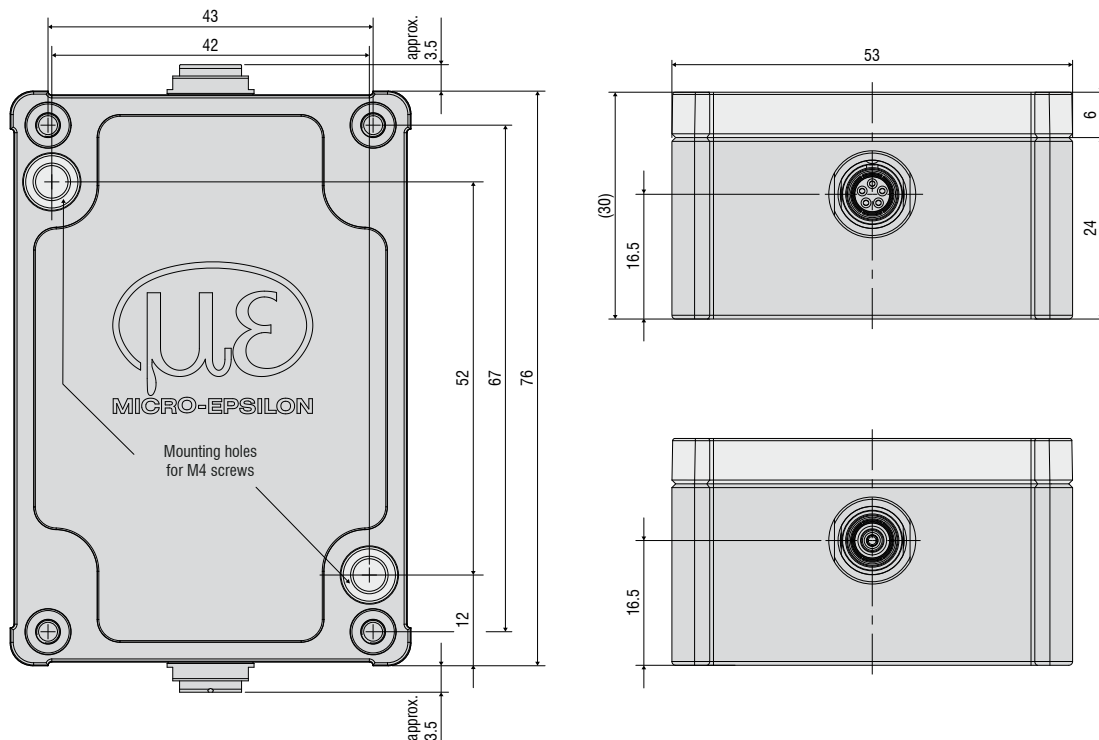



- One-sided thickness measurement in one axis
- Integrated temperature measurement
- Special plug for fast sensor connection
- Thickness measurement based on  $\epsilon_r$
- Determination of  $\epsilon_r$  with known thickness
- Ease of use via web interface

In its sensor housing, the combiSENSOR combines an eddy current displacement sensor and a capacitive displacement sensor. This unique sensor concept enables one-sided thickness measurement of electrically non-conductive materials on metallic objects. Its field of application is the absolute thickness measurement of plastic film or of plastic coating on metal plates. Connected to the sensor via a cable, the controller processes and calculates the signals in order to put them out via interfaces. Calculation of the two sensor signals provides compensation of mechanical changes such as thermal expansion, deflections or eccentricity in the measurement device. Due to the redundancy of this combined sensor principle, the measured thickness value remains unaffected by any changes in the measurement setup. Due to the high temperature stability, the combiSENSOR provides high measurement accuracy even with fluctuating temperatures.

#### Fields of application

- Non-contact thickness measurement of plastic films
- Non-contact thickness measurement of coated metals
- Measurement of the applied adhesive
- Lateral profile due to a traversing axis



#### Web interface

The web interface for sensor and controller configuration opens via Ethernet.

#### Measuring principle

The construction of the eddy current measurement coil and the capacitive measurement electrodes is concentric. Both sensors measure against the same spot. The signal of the capacitive displacement sensor is a function of the working distance, the thickness of the insulator (D) and the dielectric constant of the insulator material ( $\epsilon_r$ ). At the same time the eddy current displacement sensor measures the distance to the ground electrode (e.g. metal sheet or metal roller positioned behind the film). The controller outputs both single signals as well as the difference between capacitive sensor and eddy current sensor. Also the dielectric constant can be calculated with known thickness and working distance.

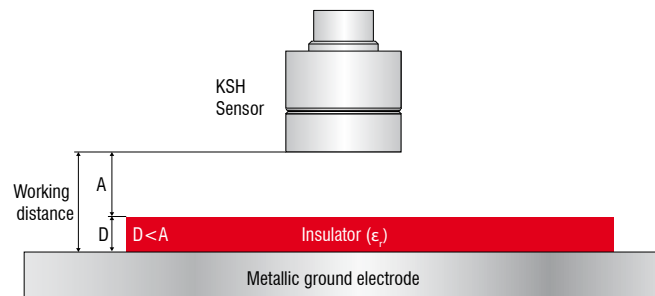

#### Thickness measurement:

If the dielectric constant  $\epsilon_r$  and the working distance from the ground electrode are known, the controller calculates the insulator thickness D from the sensor signals.

#### Calculation of the dielectric constant:

If the thickness of the Insulator D and the working distance from the ground electrode are known, the controller calculates the dielectric constant of the insulator.

Controller type		KSS6420	KSS6430	KSS6420(01)	KSS6430(01)
Sensor		KSH5(01)		KSH10	
Target thickness (insulator thickness) <sup>1)</sup>		40 μm ... 3 mm		40 μm ... 6 mm	
Working distance		2 mm ... 5 mm		4 mm ... 10 mm	
Min. diameter measurement surface		45 mm		65 mm	
Resolution <sup>2) 3)</sup>	static, 100 Hz	0.0018 % FSO	0.0004 % FSO	0.0030 % FSO	0.0006 % FSO
	dynamic, 3.9 kHz	0.0075 % FSO	0.0015 % FSO	0.0120 % FSO	0.0025 % FSO
Bandwidth		analog: 1 kHz (3 dB) <sup>4)</sup> , digital: 2.6 ... 3900 Sa/s (adjustable)			
Linearity		≤ ±0.05 % FSO			
Temperature stability	Sensor (+10 ... +50 °C)	±50 ppm			
	Controller (+10 ... +50 °C)	±50 ppm	±50 ppm	±50 ppm	±70 ppm
Temperature range	Operation	controller: +10 ... +60 °C; sensor: -10 ... +85 °C; sensor cable: -10 ... +125 °C			
	Storage	sensor, cable: -10 ... +100 °C; controller: 0 ... +75 °C			
Supply		12 ... 36 VDC (5.5 W)			
Output	Analog	capacitive, eddy current and differential signal: 0 ... 10 V (short circuit proof); internal sensor temperature signal (not scaled)			
	Ethernet	capacitive, eddy current, differential and internal temperature signal: 24 Bit			
	EtherCAT	capacitive, eddy current, differential and internal temperature signal: float			
Trigger		TTL, 5 V			
Target geometry		straight surface or min. diameter 200 mm <sup>5)</sup>			
Protection class		sensor: IP54, controller: IP40			
Weight		sensor: 80 g; controller: 750 g			

FSO = Full Scale Output

<sup>1)</sup> Insulator thickness below 40 μm on request; <sup>2)</sup> RMS noise related to mid of measuring range

<sup>3)</sup> Difference signal of the digital output, measured with working distance = 50 % FSO

<sup>4)</sup> only valid when sampling rate = 3900 Sa/s

<sup>5)</sup> Reference material ground electrode: VA steel (1.4571) or aluminum. Changes of the ground electrode (material or geometry) require a recalibration of sensor and controller by the manufacturer.

#### Controller

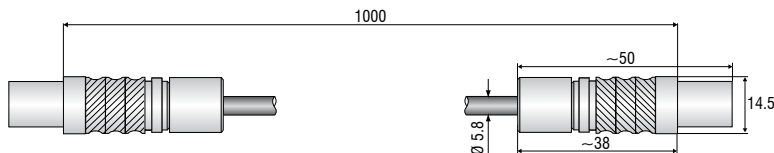
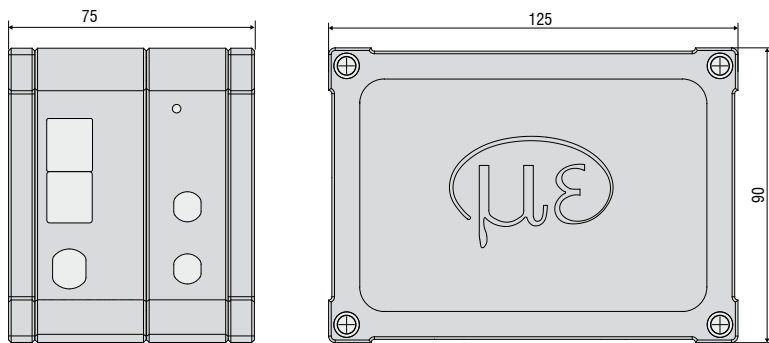

#### SCAC3/5 connector

Signal output (5-pole plug)

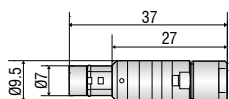

#### KSH5 sensor

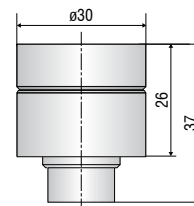

#### KSH10 sensor

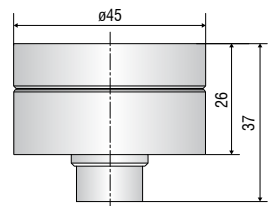

#### Scope of supply:

- KSH sensor
- Sensor cable 1m
- Controller
- PC6200 3/4 supply and trigger cable (3m)

#### Accessories:

- SCAC3/5 signal output cable analog (3m)

Sensor cable	Cable CCx,x / CCx,x/90	Cable CCmx,x / CCmx,x/90	Cable CCgx,x / CCgx,x/90
Description	Low-outgassing cable up to 4 m length, for applications in clean rooms	Low-outgassing cable up to 4.2 m length, for applications in clean rooms, UHV and EUV	Robust cable up to 8 m length, for industrial applications
Temperature stability	-100 °C to +200 °C	-100 °C to +200 °C	-20 °C to +80 °C (permanent) -20 °C to +100 °C (10;000 h)
Outer diameter	3.1 mm ±0.1 mm	2.1 mm ±0.1 mm	3.1 mm ±0.1 mm
Bending radius	3x cable diameter during installation; 7x cable diameter for movement; 12x cable diameter recommend at continuous movement		

Design	Cable with connector type C for sensors CS005 / CS02 / CS05 / CSE05 / CS08 / CSE1						Cable with connector type B for sensors CS1 / CS1HP / CSE1,25 / CS2 / CSE2 / CS3 / CSE3 / CS5 / CS10					
	2 x straight connector			1 x straight / 1 x 90° connector			2 x straight connector			1 x straight / 1 x 90° connector		
Model	CCx,xC	CCmx,xC	CCgx,xC	CCx,xC/90	CCmx,xC/90	CCgx,xC/90	CCx,xB	CCmx,xB	CCgx,xB	CCx,xB/90	CCmx,xB/90	CCgx,xB/90
Standard 1 m	•		•	•		•	•		•	•		•
1.4 m		•			•			•			•	
2 m	•		•	•		•	•		•	•		•
2.8 m		•			•			•			•	
3 m	•			•			•		•	•		
4 m			•			•		•				•
4.2 m		•			•			•			•	
6 m			•			•		•				•
8 m			•			•		•				•

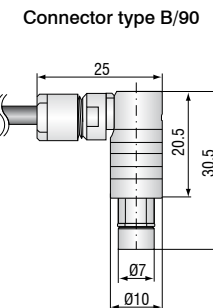
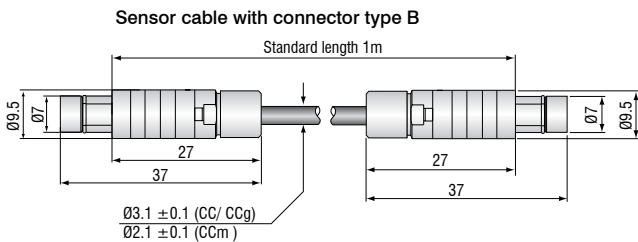
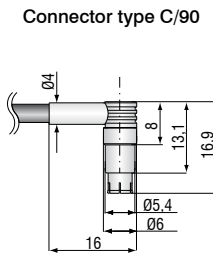
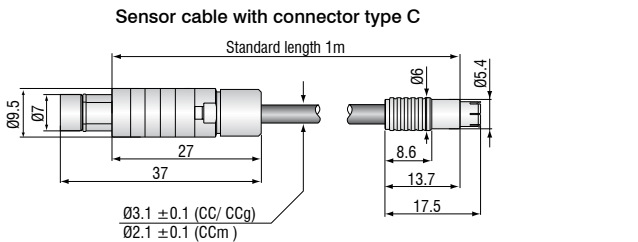

Accessories	capaNCDT	6110	6200	6500
<b>MC2.5</b> Micrometer for sensor calibration, range 0 - 2.5 mm, Resolution 0.1 µm. Suitable for sensors CS005 to CS2		•	•	•
MC25D Digital micrometer for sensor calibration, range 0 - 25 mm, adjustable offset (zero). Suitable for all sensors.		•	•	•
<b>HV/B</b> Vacuum feed through triaxial		•	•	•
<b>UHV/B</b> Vacuum feed through triaxial for ultra-high vacuum		•	•	•
<b>PC6200-3/4</b> Power-/trigger cable, 4 pin, 3 m			•	
<b>SCAC3/4</b> Signal output cable, (necessary for multi-channel applications), 4 pin, 3 m			•	
<b>SCAC3/5</b> Signal output cable, analog, 5 pin, 3 m		•		
<b>SC6000-1,0</b> Synchronization cable, 5 pin, 1 m			•	•
<b>CA5</b> Preampifier cable 5 pin, 5 m				•
<b>PS2020</b> Power supply for DIN rail mounting; Input 230 VAC (115 VAC); Output 24 VDC / 2.5 A; L/W/H 120x120x40 mm		•	•	



**HV/B Vacuum feed through (Art.-no. 0323050)**

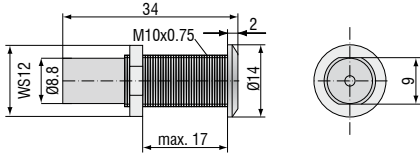

Max. leak rate  $1 \times 10^{-7}$  mbar · l s<sup>-1</sup>, compatible with connector type B

**UHV/B Vacuum feed triax weldable (Art.-no. 0323346)**

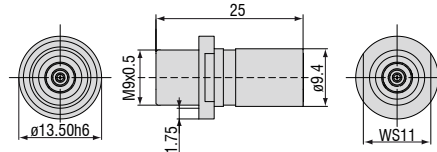

Max. leak rate  $1 \times 10^{-9}$  mbar · l s<sup>-1</sup>, compatible with connector type B

**UHV/B Vacuum feed triax with flange CF16 (Art.-no. 0323349)**

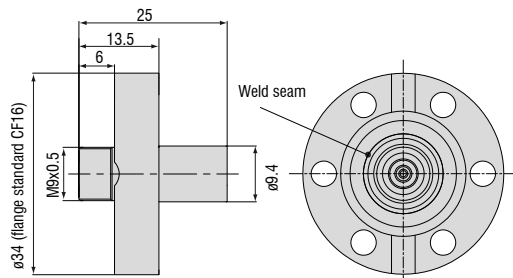

Max. leak rate  $1 \times 10^{-9}$  mbar · l s<sup>-1</sup>, compatible with connector type B

**UHV/B Vacuum feed triax screwable (Art.-no. 0323370)**

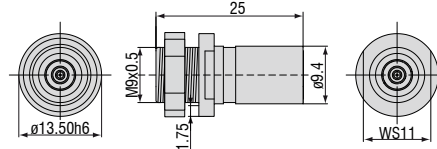

Max. leak rate  $1 \times 10^{-9}$  mbar · l s<sup>-1</sup>, compatible with connector type B

**SCAC3/4 Signal output cable (Art.-no. 2902104)**

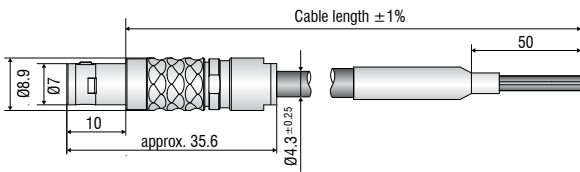

**SCAC3/5 Signal output cable (Art.-no. 2902112)**

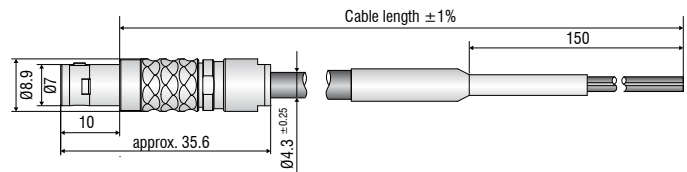

**PC6200-3/4 Power-/trigger cable (Art.-no. 2901881)**

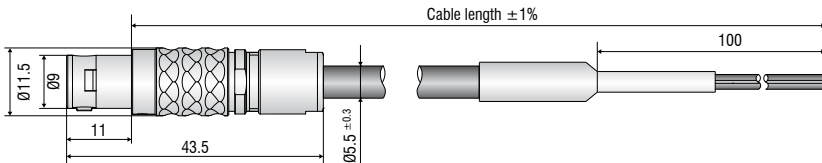

**SC6000-1,0 Synchronization cable (Art.-no. 2903473)**

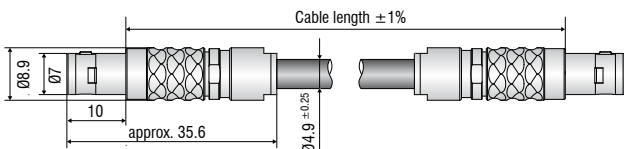

**CA5 Preamplifier cable (Art.-no. 2903180)**

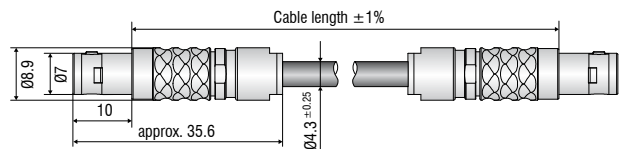

**Influence of tilting the capacitive sensor**

In the case of tilting the capacitive sensor, a measurement error must be assumed as the geometric conditions of the field for the target change. In fact, the average distance of the sensor remains constant; however, the edge areas move closer or further away from the target. This results in field distortions, which affect the capacity C according to the following model:

$$C_d(\Theta) = C_d(0) * [1 + (\frac{1}{4}) * (\frac{R^2}{d^2}) * \tan^2 \Theta]$$

$$\Delta_x = 100 * (\frac{d}{d_{MAX}}) * [ \frac{1}{1 + (\frac{R^2}{4d^2}) * \tan^2 \Theta} - 1 ]$$

- C capacity
- Θ tilt angle
- R measurement area radius
- d working distance sensor-target
- d<sub>MAX</sub> sensor measuring range
- Δx signal change

Results are based on internal simulations and calculations. Please ask for detailed information.

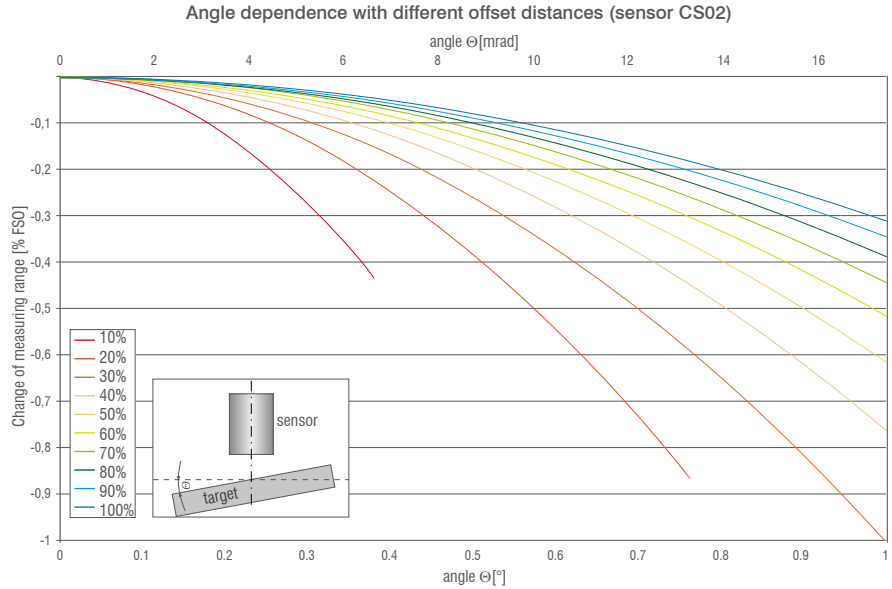

**Example illustration of the influence using the CS02 sensor as an example, consideration of a tilt angle of max. 1° for different sensor distances.**

In the case of 10% distance in the sensor axis, there is already contact between sensor housing and target at 0.38°; in the case of 20% distance, the contact is at 0.76°. The simulation can be performed for all sensors and installation conditions; tilt angles around a decentralized tilt point can also be calculated.

**Measurement on narrow targets**

The influence of the target width on the measurement signal is shown using the example of a CS05 sensor. A target extended in the y-axis, narrowed in the x-axis has been varied in different parameters:

- target-sensor distance (z-axis): 0.25mm (measuring range center)
- width of the target in the x-axis: 3 ... 8mm (21 values)
- displacement of the target in the x-axis (vertical to the sensor axis): 0 ... 3mm (13 values)

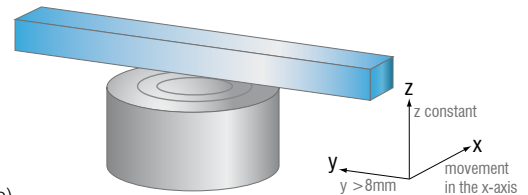

In each case, the capacity between electrode and target and its reciprocal (this is proportional to the sensor signal of the controller) were calculated. The diagram shows the deviations from the capacity values for a flat target (large opposite sensor in x and y axes) depending on the target width and displacement. The smaller the distance between sensor and target, the narrower the target can be. In the example, a centrally placed target with a width of 5mm is sufficient to achieve a stable signal in the center of the measuring range. This proves that the field does not spread beyond the sensor diameter.

Results are based on internal simulations and calculations. Please ask for detailed information.

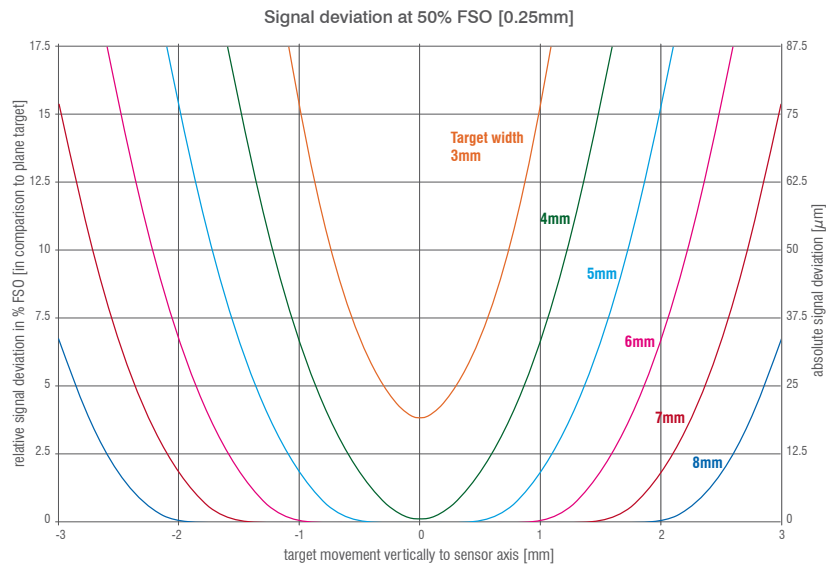

### Force effects on the target

The capacitive measuring principle is reactionless. In specific cases, the force can be calculated with the following formula:

$$F = \frac{C * U^2}{(2 * d)} = \text{constant}$$

$$F = \frac{\epsilon_0 * \epsilon_R * A * E^2}{2} = \text{constant}$$

$$F = \frac{1}{2} * E * Q = \text{constant}$$

Using the example of a CS1 sensor, which is operated using the DT6230/DT6500 system, a force of approx.  $0.23\mu\text{N}$  is produced. The force however is dependent on the selection of sensor and electronics, not on the sensor's position over the measuring range. The DT6110/6220 systems operate using lower measuring currents, whereby the electrical field and the electrical voltage are lower so that the force is only  $0.01\mu\text{N}$  and so measurement without feedback is assumed.

### Measurements on spheres and shafts

In practice, it is often necessary to measure curved surfaces. A classic example is shaft runout measurements, where a cylindrical target is measured. Compared to a flat target, there are either more or less significant measured value deviations depending on the bending radius in doing so. This is caused by various effects, e.g. concentration of the field lines at the highest point or a capacity increase due to a larger measuring spot.

In reality, it can be assumed that the bending radius results in a virtual zero point, i.e., the sensor value 0 can no longer be achieved. Due to the integrating function of the capacitive sensor over the measurement surface, the virtual, average measuring plane lies behind the surface line. For example, this means that with a  $200\mu\text{m}$  sensor and a roller with an external diameter of  $30\text{mm}$  and a gap clearance of  $20\mu\text{m}$ , almost 5% more is indicated, i.e. approx.  $30\mu\text{m}$ . As this effect can be calculated, corresponding characteristics can be calibrated in the evaluation electronics.

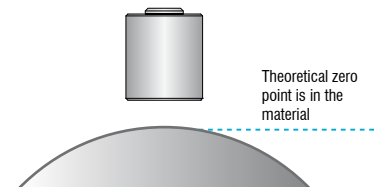

Signal change: various target geometries (sensor CS02)

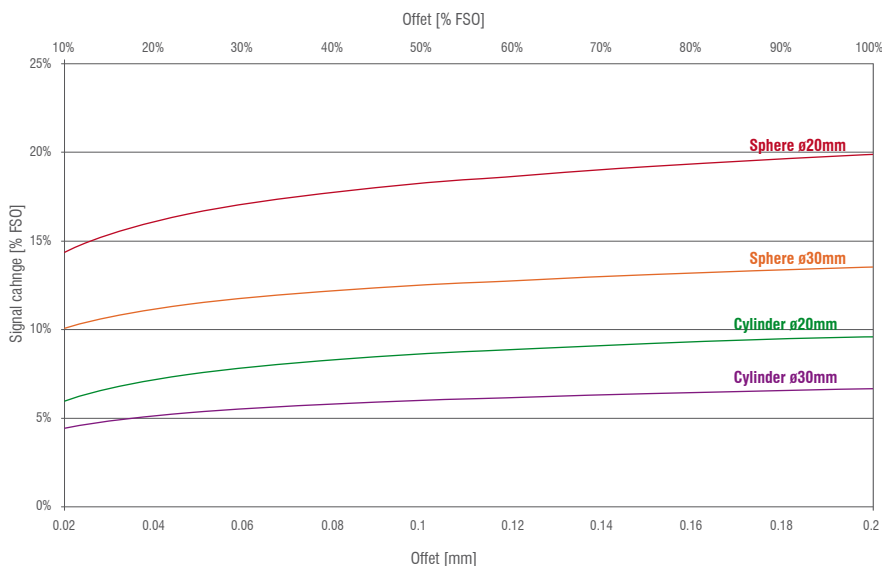

Results are based on internal simulations and calculations. Please ask for detailed information.

### Consideration of the conductivity requirements

In order to achieve a linear output signal across the complete measuring range, certain requirements for the target or the counter electrode must be complied with.

The impedance in the ideal plate capacitor can be shown in the equivalent circuit diagram by a capacitor and a resistor connected in parallel. For measurement against metals, the Ohm part can be disregarded; the impedance is only determined by the capacitive part.

Conversely, only the Ohm part is considered for measurements against insulators. In between, there is the large range of semiconductors. Most semiconductors can be measured very well as electrical conductors. The requirement is that the capacitive part of the total impedance is still significantly larger ( $>10x$ ) than the ohmic part. This is almost always the case for silicon wafers irrespective of the endowment.

Nevertheless, semiconductors with poor conductivity (e.g. GaAs) can also be measured as conductors under certain circumstances. However, various adjustments are required for this, e.g. reduction of the operating frequency or a temporary, partial increase of the conductivity.

Relation between conductivity and suitability of materials

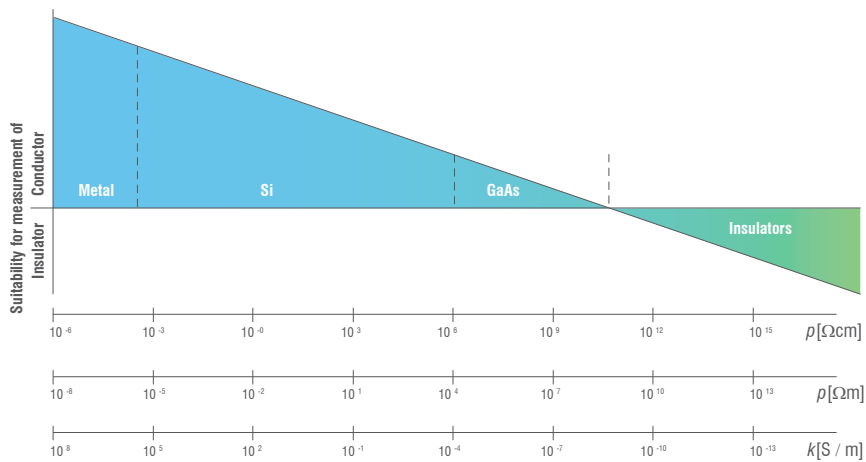

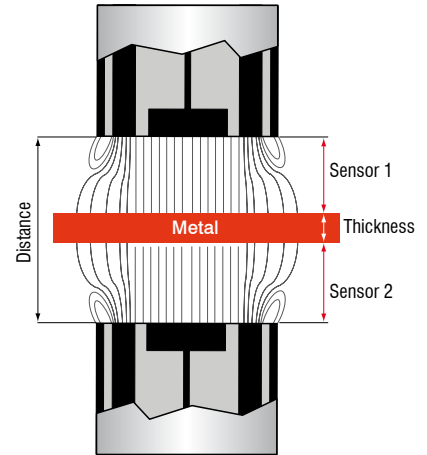
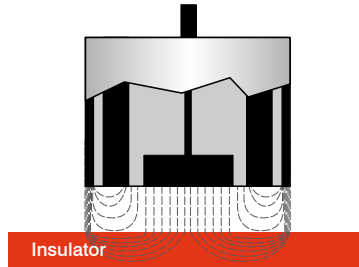
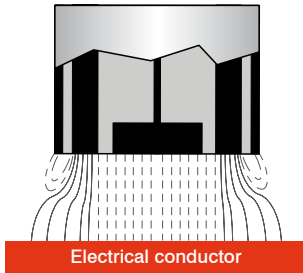

$$\text{Thickness} = \text{Distance} - (\text{Sensor 1} + \text{Sensor 2})$$

**Electrical conductor as target**

The capaNCDT system measures the reactance  $X_c$  of the capacitor, which changes proportionally with distance. The high linearity of the signal is achieved without further electronic circuitry. This particularly applies to measurements against electrically conductive materials (metals). Changes of the conductivity have no influence on linearity or sensitivity. All conductive or semi-conductive targets are measured without any loss in measurement performance.

**No penetration of the fields for electric conductors**

As the measurement principle operates without penetration of the fields in the target, even the thinnest targets, e.g. 10  $\mu\text{m}$  electrically conductive paint, can be measured. The capacitive measuring process operates with currents in the  $\mu\text{A}$  range. This means even the smallest electrical charges are sufficient to make measurements possible. Even very thin metallic objects can guarantee the charge carrier displacement. A target thickness of a few micrometers is sufficient here. The electrical field develops between sensor electrode and target surface; the distance determines the reactance.

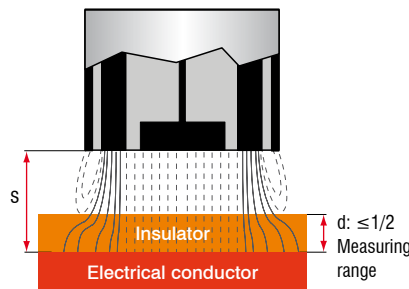

**Thickness measurement of insulators**

The capaNCDT system can also be used for the linear thickness measurement of insulators. The field lines penetrate the insulator and join with the electrical conductor. If the thickness of the insulator changes, this influences the reactance  $X_c$  of the sensor. The distance to the electrical conductor must therefore be constant.

**Thickness measurement of metals**

Two-sided thickness measurement of metals is made possible by installing the sensors opposite each other. Strip thicknesses in the  $\mu\text{m}$  range can be measured using this method. Each sensor generates a linear output signal dependent on the distance between sensor surface and target surface. If the sensor distance is known, the thickness of the target can be determined easily. Due to the capacitive principle, the measurement is only performed against the surface without penetrating the target. If the measuring points are synchronized, measurement against non-grounded targets is possible.

$$\frac{C}{C_0} = \frac{1}{\left(1 - \left(\frac{d}{s}\right) * \left(1 - \frac{\epsilon_1}{\epsilon_2}\right)\right)}$$

$$\epsilon_1 = \epsilon_0 * \epsilon_{r1}, \epsilon_2 = \epsilon_0 * \epsilon_r$$

- $d$  Target thickness
- $s$  Measuring gap
- $\epsilon_1$  Permittivity air
- $\epsilon_2$  Permittivity insulator

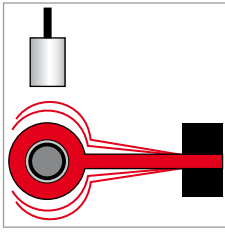

Vibration, amplitude, clearance, run-out

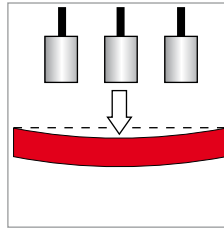

Deflection, deformation, waviness, tilt

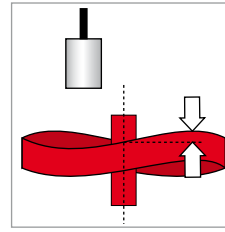

Stroke, deformation, axial shaft oscillation

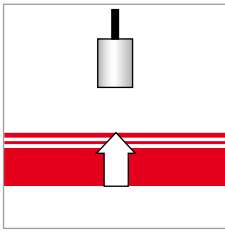

Displacement, distance, position, elongation

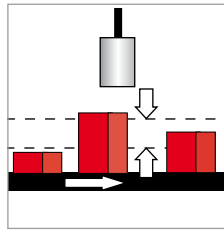

Dimensions, dimensional tolerances, sorting, parts recognition

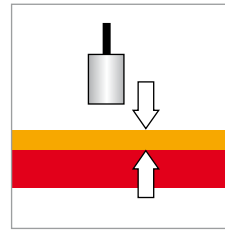

Thickness measurement of insulating materials

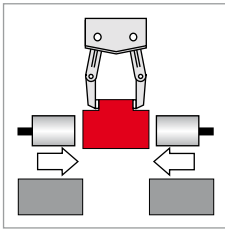

In-process inspection, dimensional inspection

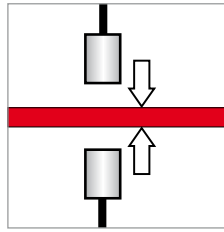

Two-sided thickness measurement

**Specific sensors for OEM applications**

Application examples are often found where the standard versions of the sensors and the controller are performing at their limits. For these special tasks, we modify the measuring systems exclusively according to your individual requirements. Changes requested include, for example, modified designs, target calibration, mounting options, individual cable lengths, modified measuring ranges or sensors with integrated controller.



Customized sensor body



Customized modification for a specific environment



Special OEM design

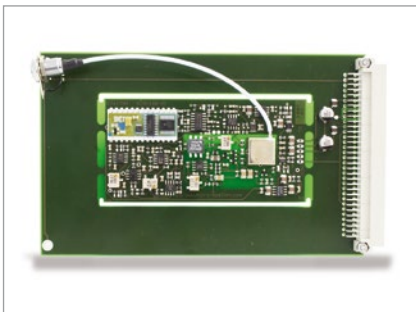

Special OEM electronic design



Measuring device to check the inner diameter of extruder bore holes (2 sensors in one axis)



Dual sensor with 2 capacitive sensors in one housing

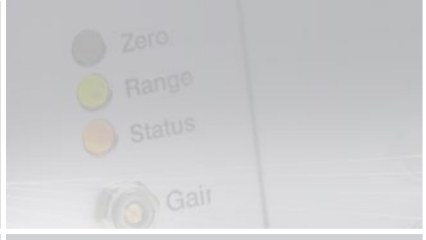

**Thickness measurement of dies for optical data carriers**

Previously, the data was transferred to a master system using a laser to reproduce CDs, DVDs, HD-DVDs or Blu-ray discs by pressing. A thin layer of nickel is applied using galvanization to the silicon or glass carrier (substrate). The absolute thickness values of the nickel layer are required in order for the exact control of the galvanization bath. Capacitive sensors from Micro-Epsilon are used to measure the thickness and profile. A sensor is positioned above and below the die, which is then moved between the sensors during measurements. Using the two units for distance information, the thickness is determined very precisely using the differential method.

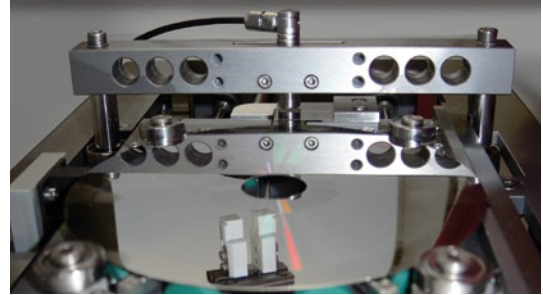

**Modular measuring system for the profile measurement of blown films**

The measuring of the film profile already on the film bubble provides important data for extrusion control. In order to make the process as efficient as possible, a modular blown film measuring system was designed by Micro-Epsilon, which is installed immediately after the calibration cage. The system is available with contact and non-contact sensors. The sensor system used for profile measurement is based on the capacitive measuring principle, which reliably and accurately ascertains the profile of the film. The capacitive sensors used can be distinguished by their extreme precision and signal quality.

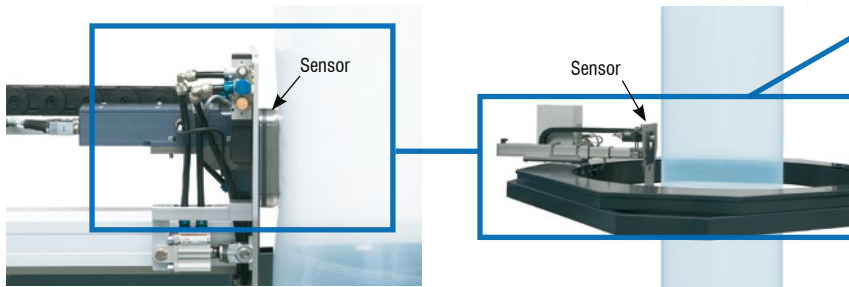
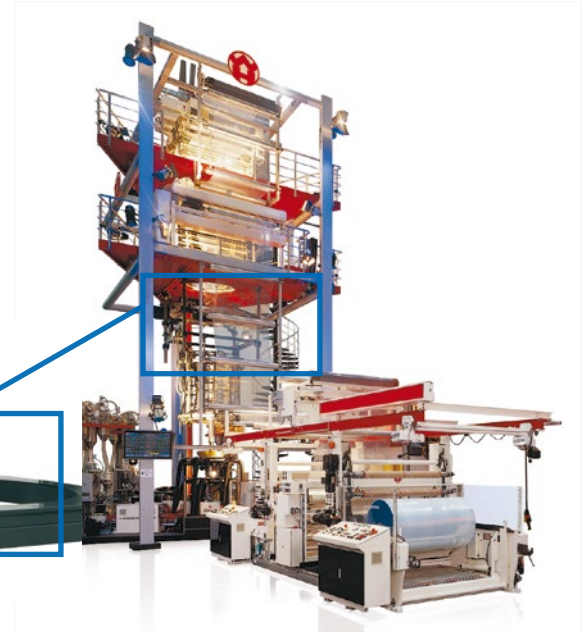

Contacting sensor

Non-contact sensor

**Measurements on wafers and semiconductors**

Extreme accuracies are required in the semiconductor industry in order to design processes and products efficiently. Capacitive sensors from Micro-Epsilon are used, among other things, for the positioning, displacement measurement and thickness measurement in the semiconductors area.

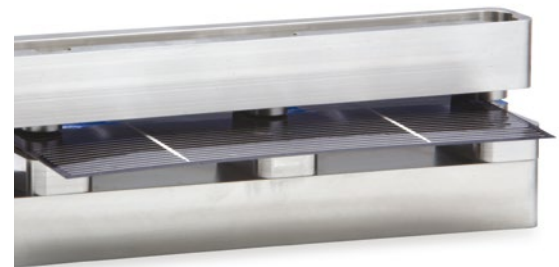

Wafer thickness measurement with 3 tracks



Capacitive displacement sensors are used for adjustment with nanometer precision of lenses in optical systems for wafer exposure.



Wafer thickness measurement with two capacitive sensors

## Sensors and Systems from Micro-Epsilon



Sensors and systems for displacement, distance and position



Sensors and measurement devices for non-contact temperature measurement



Measuring and inspection systems for metal strips, plastics and rubber



Optical micrometers and fiber optics, measuring and test amplifiers



Color recognition sensors, LED analyzers and inline color spectrometers



3D measurement technology for dimensional testing and surface inspection